

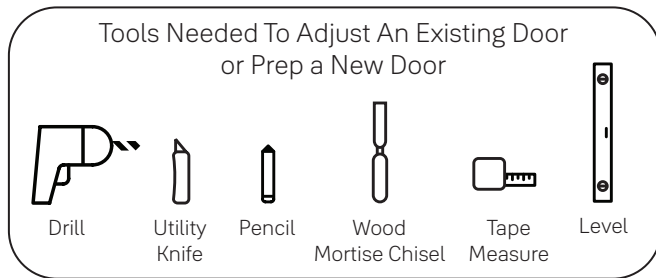

# Yale Assure Lock® 2 Key-Free Deadbolt Installation Guide (Keypad YRD430 or Touchscreen YRD450)



**Notice:** Before installing your lock, be sure to follow the steps on the yellow Quick Start Guide.



Failure to follow these instructions could result in damage to the product, voiding the factory warranty and could lead to failure of the product to provide access.



# In The Box

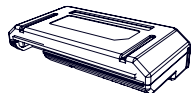

Yale Smart Module  
(with select models)

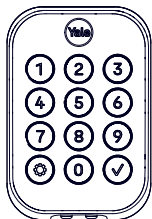

Exterior Keypad

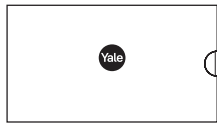

Guide



Battery Cover

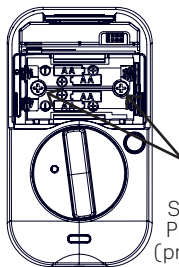

Interior Lock



x2

Screws and Plastic Clips  
(pre-installed)

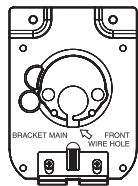

Mounting Plate

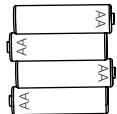

x4

Batteries

## Hardware Components

### DoorSense

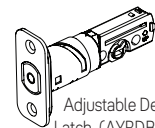
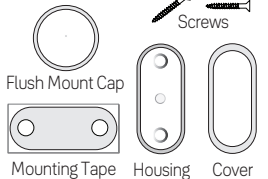

Adjustable Deadbolt Latch (AYRDB DRIVE Adjustable Drive-In Deadbolt Latch available for purchase)

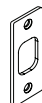

Strike Plate



x2

Optional Security Strike Plate Screws

### Reset Pin



x4

Strike Plate and Deadbolt Screws x20mm



x2

Screw Set B Blue for 1-3/8" Door Thickness



x2

Screw Set C Black for Standard 1-3/8" - 1-3/4" Door Thickness



x2

Screw Set D Silver for 2" - 2-1/4" Door Thickness

**Note:** You must use the provided screws from the hardware pack when installing this lock.



# Remove Existing Deadbolt



Keep your old deadbolt until your new lock has been successfully installed.

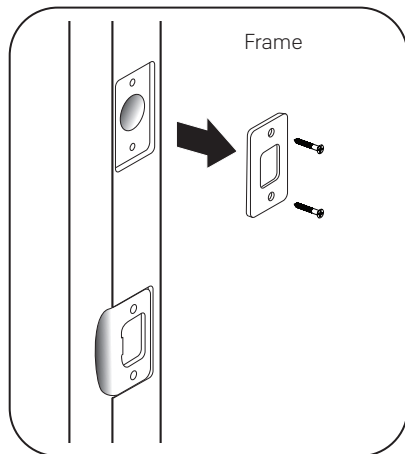
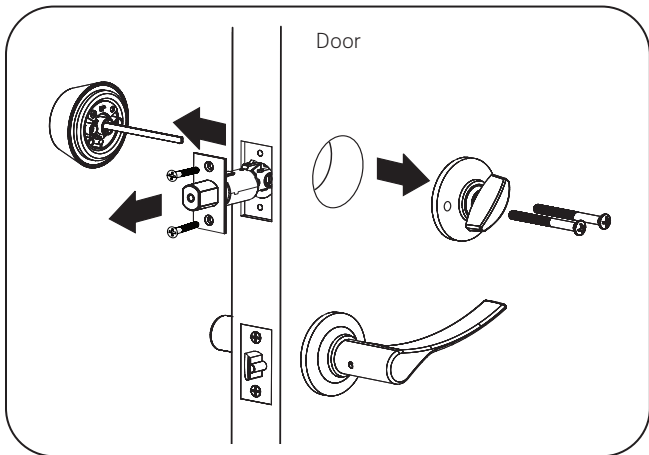



# Verify Measurements with the Check Your Door Guide

## Measure Clearance

✓ Greater than A

✗ Less than A  
(Your door is not a match for a Yale smart lock)

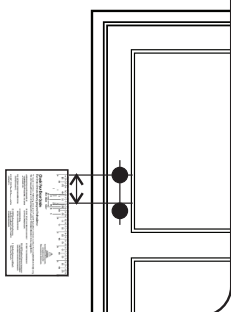

## Measure Door Thickness

✓ B, C, or D

✗ Less than B  
(Your door is not a match for a Yale smart lock)

✗ Greater than D  
(Your door is not a match for a Yale smart lock)

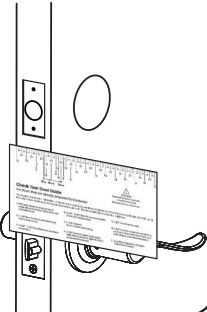

## Measure Backset

✓ Equals E or F

✗ Less than E or F  
(Your door is not a match for a Yale smart lock)

✗ Greater than E or F  
(Your door is not a match for a Yale smart lock)

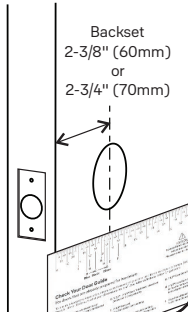

## Measure Face Bore

✓ Equals G or H  
2-1/8" (54mm)  
OR

✗ Less than G  
1-1/2" (38mm)  
(Adjust diameter to G or H)

✗ Greater than H  
(Your door is not a match for a Yale smart lock)

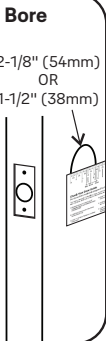

## Measure Cross Bore

✓ Equals I

✗ Less than I  
(Adjust diameter to 1")

✗ Greater than I  
(Your door is not a match for a Yale smart lock)

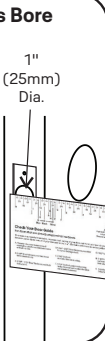

## Measure Strike Pocket Diameter and Depth

✓ Equals I

✗ Less than I  
(Adjust diameter and depth to 1")

✗ Greater than I  
(Your door is not a match for a Yale smart lock)  
1" (25mm) Dia.  
1" (25mm) Deep

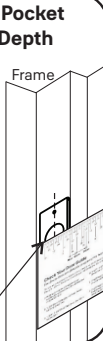

## Recommended Location of DoorSense

✓ A: Within 2" of Yale logo on battery cover.

✓ G: Within 1-1/2" from inside frame edge.

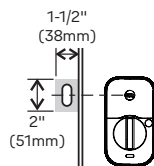

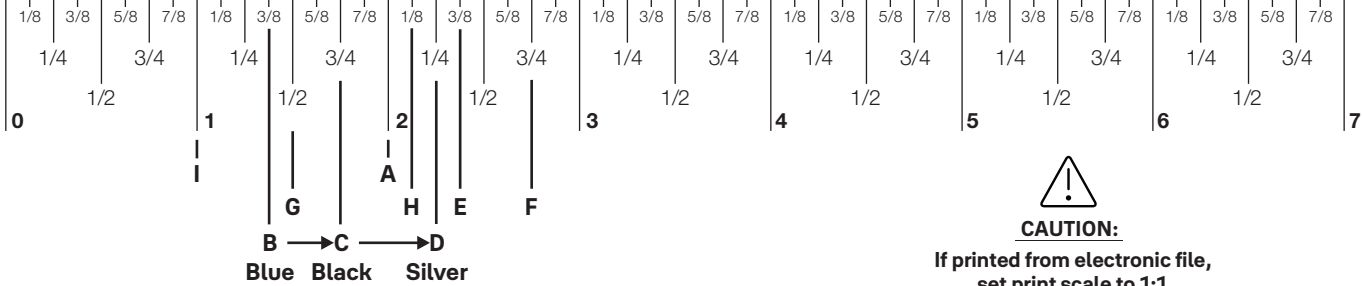

**CAUTION:**  
**If printed from electronic file,**  
**set print scale to 1:1.**  
**Measure ruler to check scale.**

## Check Your Door Guide

To ensure a successful installation, measure each aspect of your door and frame, as shown in panels (left side of sheet) using the ruler above. Make sure all of your dimensions are a ✓. See letter definitions below for guidance.

- A. 2" Minimum clearance between top of existing lever/knob rose (trim) and center of deadbolt hole.  
2" tolerance for optimal Door Sense location.
- B. 1-3/8" Door Thickness; use blue Screw Set B (shortest set).
- C. 1-3/8" - 1-3/4" Door Thickness; use black Screw Set C.
- D. 2" - 2-1/4" Door Thickness; use silver Screw Set D (longest set).
- E. 2-3/8" Backset; use Out of Box latch setting.
- F. 2-3/4" Backset; adjust latch setting. Instructions on how to adjust the latch are included in manual.
- G. 1-1/2" Face Bore Diameter. Instructions on how to remove the black adapter from the lock are included in manual. 1-1/2" tolerance from inside door frame edge for optimal DoorSense location.
- H. 2-1/8" Face Bore Diameter.
- I. Edge Bore Diameter and Depth. Cross Bore Diameter.

# Template to Mark a Door for 2-1/8" Face Bore

For 1-3/4"  
(44.5mm)  
Thick Door

Center  
of 1" (25mm)  
hole through  
edge of door

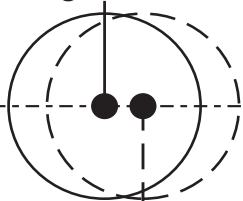

Center  
of 1" (25mm)  
hole through  
edge of door



For 1-3/8"  
(35mm)  
Thick Door

2-3/4" (70mm) Backset

FOLD OVER DOOR EDGE

Centerline

Center  
of 2-1/8" (54mm)  
hole through face  
of door

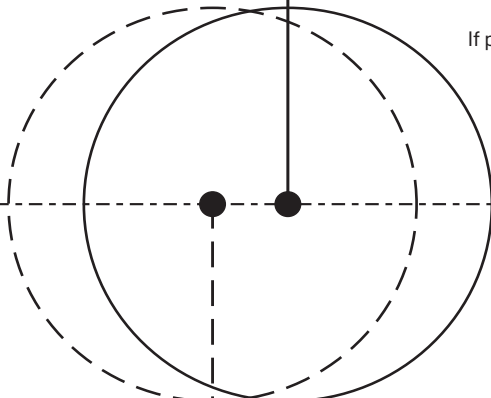

Center  
of 2-1/8" (54mm)  
hole through face  
of door

2-3/8" (60mm) Backset



### CAUTION:

If printed from electronic file,  
set print scale to 1:1.  
Measure a dimension  
to check scale.

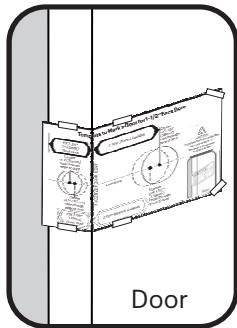

Cut Here

# Template to Mark a Door for 1-1/2" Face Bore

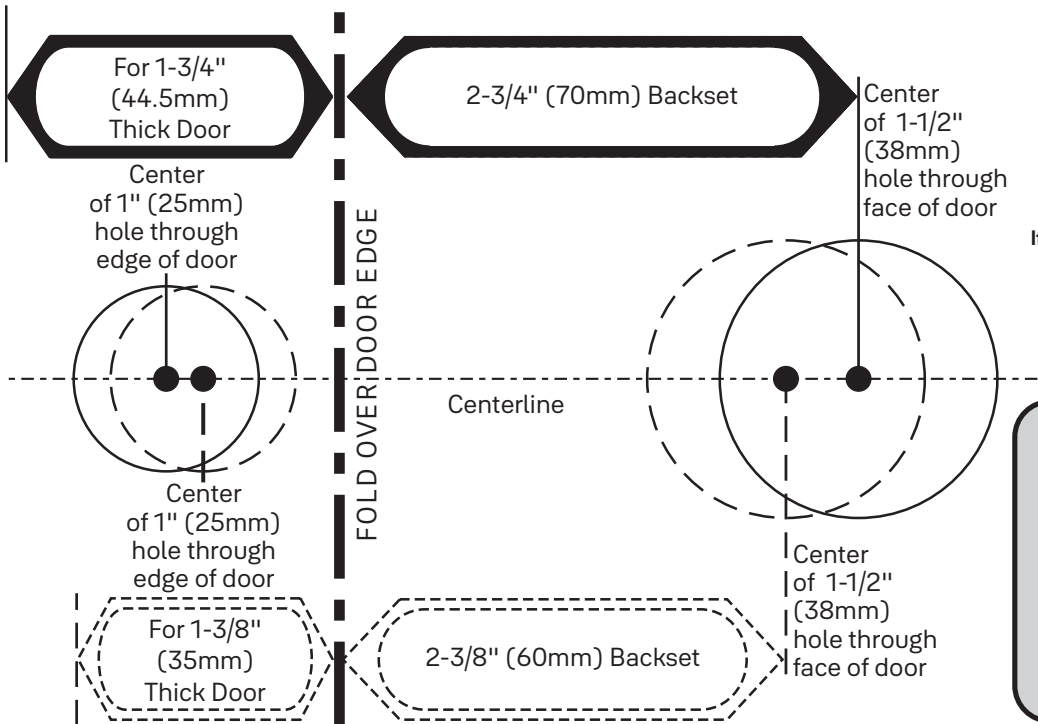

### **CAUTION:**

If printed from electronic file,  
set print scale to 1:1.  
Measure a dimension  
to check scale.

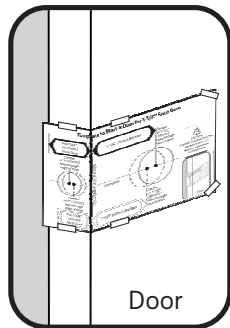



# 3

## Install Deadbolt Latch and Strike Plate



\*Correct deadbolt latch length is based on backset. Choose 2-3/8" or 2-3/4".  
Door Checker measurements E and F can help you verify your backset measurement.

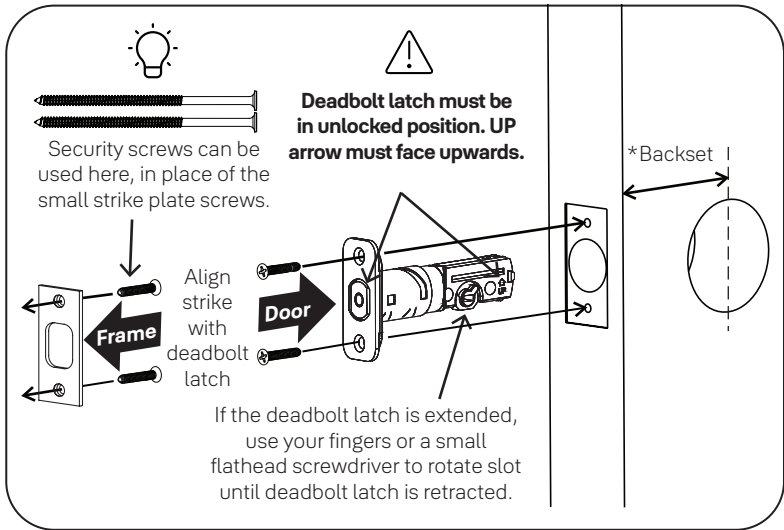
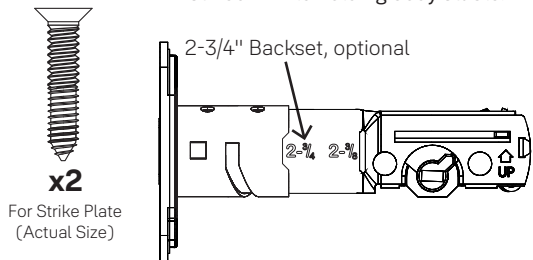
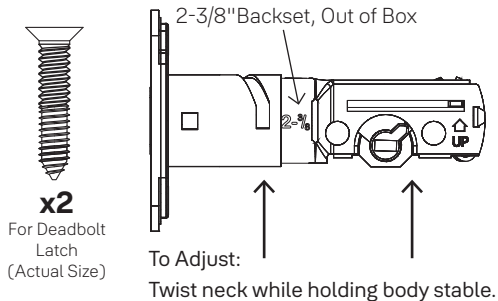

# 4

## Verifying Bore Face Measurement for Exterior Keypad



Measurement G on the Door Checker will help verify your bore face measurement.

If hole is less than 2-1/8", remove adapter by unscrewing the two screws on either side, using a Phillips #2 screwdriver.

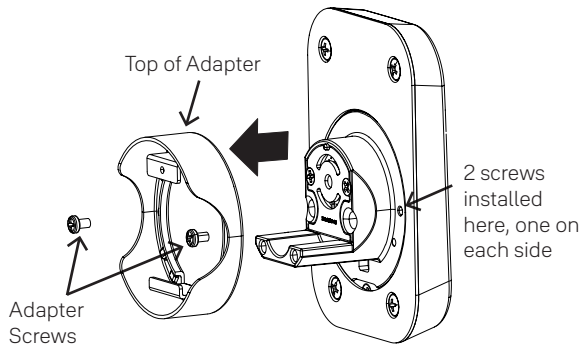

Install the lock with the door open.  
Do not close until all steps are completed.

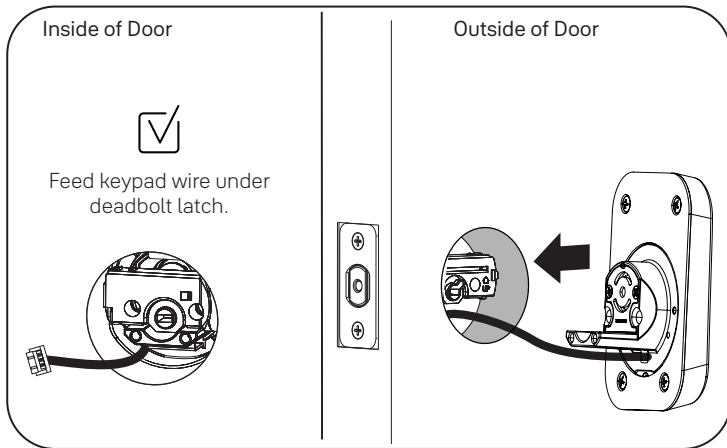

Once confirming your bore face measurement is correct, you are ready to install the Mounting Plate and Keypad.

# 5



## Install Mounting Plate and Exterior Keypad

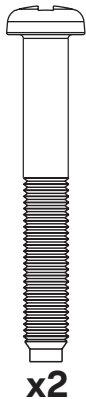

Bolt Set C, Black  
for a Standard  
1-3/8" - 1-3/4"  
Door Thickness



### IMPORTANT:

**There are 3 bolt sets with your lock. Choose the bolt length for your door thickness.**

Measurement B, C, or D on the Door Checker will help you identify which bolts to use.

1-3/8" Door Thickness;  
use blue Screw Set B  
(shortest set)

1-3/8" - 1-3/4" Door Thickness;  
use black Screw Set C

2" - 2-1/4" Door Thickness;  
use silver Screw Set D  
(longest set)

### Inside and Outside of Door

Position keypad on the outside of door, feeding wire as shown.

Hold keypad to front of door, while positioning plate to inside of door.

Guide wire through the 'front wire hole' in plate.

Insert 2 bolts through the plate.

Hand tighten bolts with a Phillips screwdriver, ensuring plate and keypad are straight.



Use Phillips screwdriver when attaching mounting plate bolts to keypad.

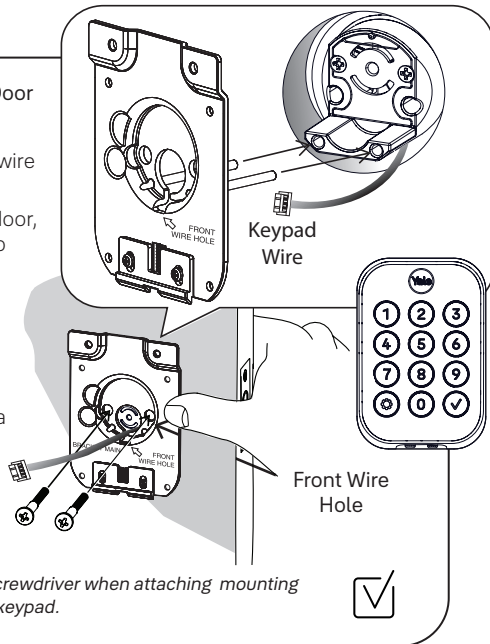

# 6

## Attach Wire to Inside of Interior Lock

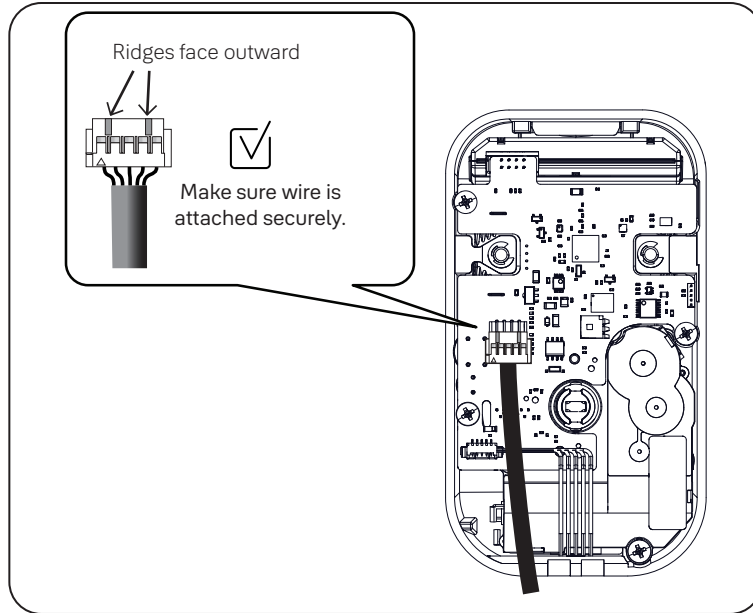



## Install Interior Lock

Tailpiece must be horizontal.  
Thumbturn must be vertical.  
Insert tailpiece through deadbolt latch slot.

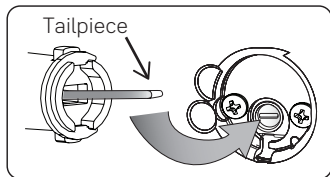

Push the lock towards the door, adjusting the position until the plate spring latch 'clicks' into place and holds the bottom of the lock.

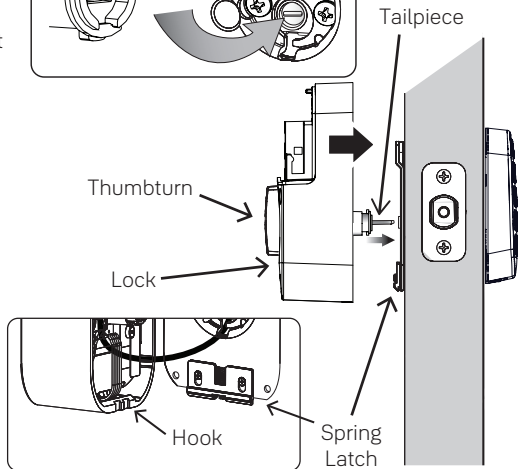

Screws are pre-installed. Tighten when lock is seated on plate.  
When fully tightened, lock should be flush to door.

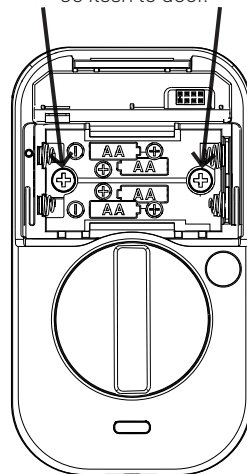



# Test Thumbturn and Key



Smooth deadbolt latch operation will enhance your battery life.

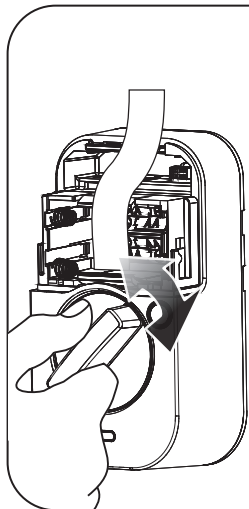

If deadbolt latch does not lock or unlock when turning thumbturn:

Ensure tailpiece is inserted through deadbolt latch slot.  
Step 7

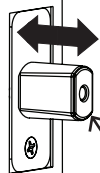

If deadbolt latch does not lock or unlock when using the keypad or lock door button:

Ensure deadbolt latch is centered in face bore hole.  
Step 3

Ensure tailpiece is inserted through deadbolt latch slot.  
Step 7

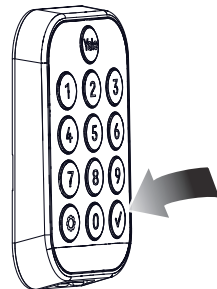
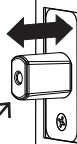



# Install Yale Smart Module

Included with select models

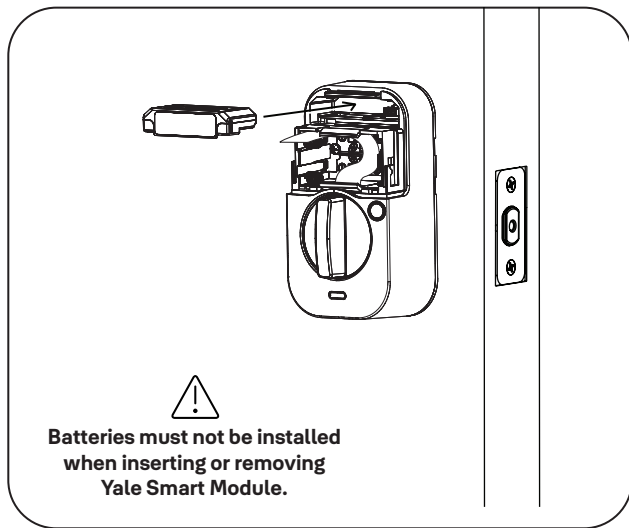



## Install Batteries and Replace Cover

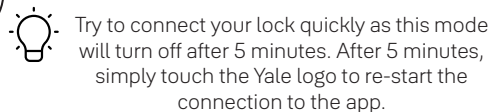
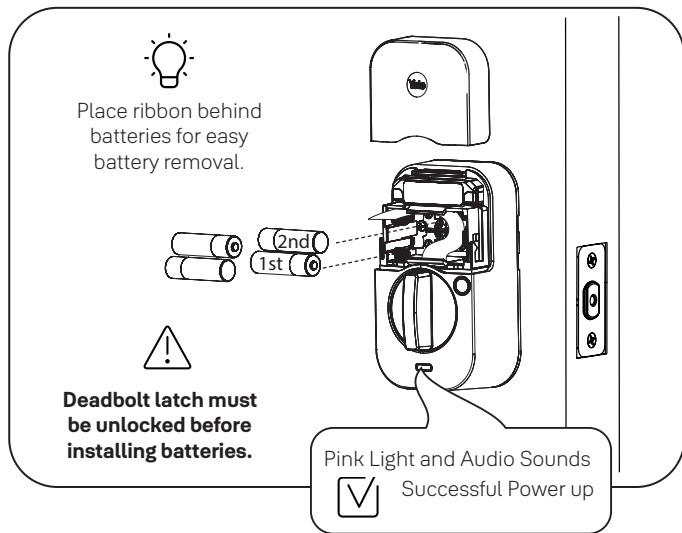

**Congratulations, you've installed the Yale Assure Lock® 2 Keyed Deadbolt!**





## Installing DoorSense®

### Installation options:

1. Surface Mount: Only requires only the use of a screwdriver.
2. Flush Mount: Provides a cleaner and less visible look with more robust performance, but does require drilling a  $\frac{5}{8}$ " hole into your door frame.

### What's in the box?

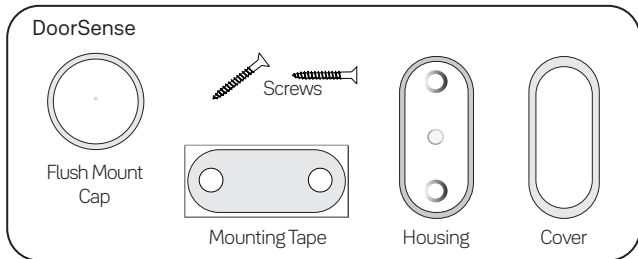

### What you'll need

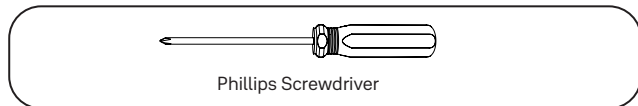

## Surface Mount Installation

### Step 1. Determine mounting location

For optimal performance, DoorSense should be mounted within 1.5" from the edge of your door frame, and align with your lock's Smart Module (if you are installing one).



Ensure it is in the proper position with its center aligned with the Yale logo.

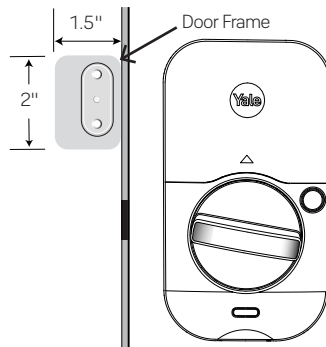

# 9

## Installing DoorSense®

### Step 2. Attach mounting tape

A. Remove one side of the adhesive.

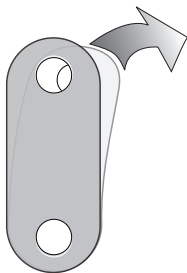

B. Attach tape to the back of the DoorSense, ensuring it is aligned with the edges of the device and screw holes.

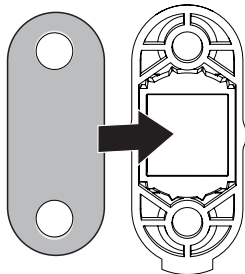

C. Remove the remaining piece of adhesive.

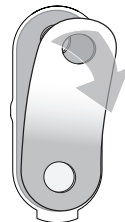

### Step 3. Place on door frame

Press the adhesive side to the frame.

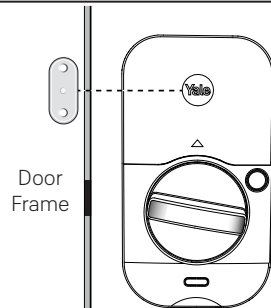

# 9



## Installing DoorSense®

### Step 4. Screw into frame

Hand tighten to the frame using the included screws.

You may wish to complete this step after your lock is set up and calibrated to ensure you are able to retrieve accurate door state readings before modifying your door frame.

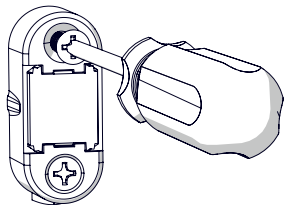

### Step 5. Attach the cover

Press the cover onto the DoorSense unit.

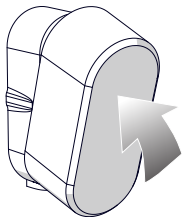

**Notes:** Once the lock has been set up, navigate to the Lock Settings and select Calibrate Lock.

Follow the instructions in the app.

Open and close the door to validate the door state is accurate. If it is not accurate or the calibration was unsuccessful, relocate the DoorSense closer to the smart lock and repeat the calibration process until you get accurate results.

If you elected to not insert the screws into the door frame, go back and secure them into your door frame or wall. Place the cover over the housing.

If you notice that your readings are not accurate over time, perform another Calibration.

# 9

## Installing DoorSense®

### Flush Mount Installation

#### What you'll need

- Flush Mount Cap (shown in illustration on page 16.)
- 5/8" drill blade bit • Electric drill

#### Step 1. Remove magnet from the housing

Use a small blunt object to push the magnet carrier out of the housing.

This may require some force.

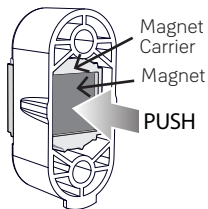

#### Step 2. Assemble magnet to cap

A. Expose the adhesive by removing the blue backing.

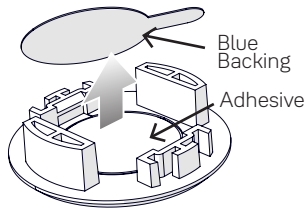

B. Press the cap onto the notched side of the magnet carrier.

The two shapes should interlock.

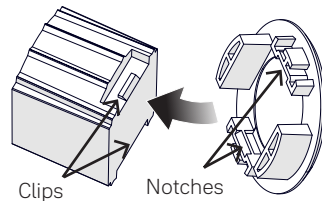

#### Step 3. Determine mounting location

DoorSense is mounted 1.5" at most from the top edge of the strike plate and centered on the door frame.

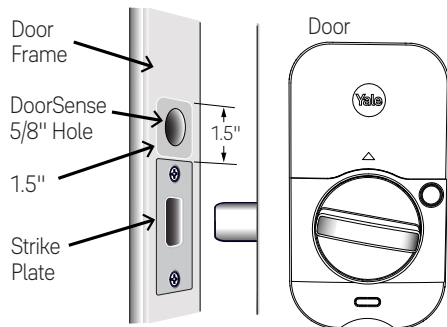



## Installing DoorSense®

### Step 4. Tape drill bit

It may be helpful to attach tape to your drill bit to mark the proper depth of hole to drill.

Although DoorSense requires a 1/2" deep hole, it may be helpful to use the assembled DoorSense Flush Mount as a guide.

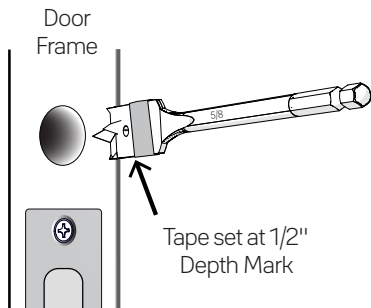

### Step 5. Drill hole

Drill the hole in the proper location on your door frame.

### Step 6. Insert DoorSense into the hole

If it is too snug to push in by hand, protect the frame with a piece of scrap wood and use light blows with a hammer or mallet.

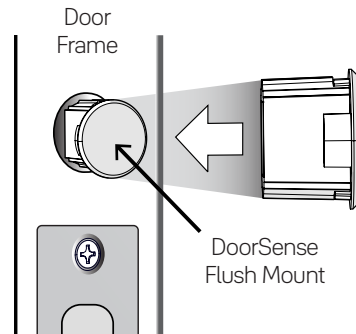

### Step 7. Calibrate your Lock

Follow the instructions in the app until you have successfully calibrated your lock and DoorSense.





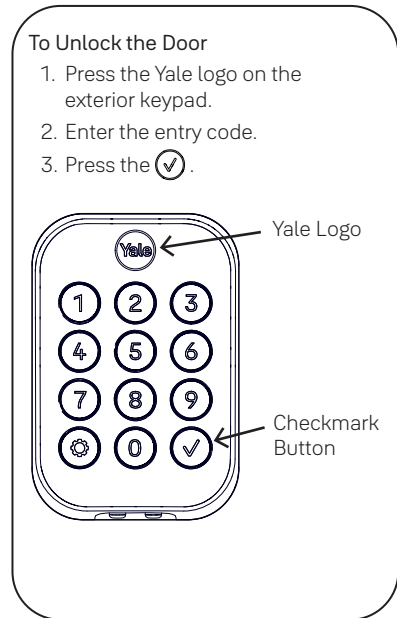
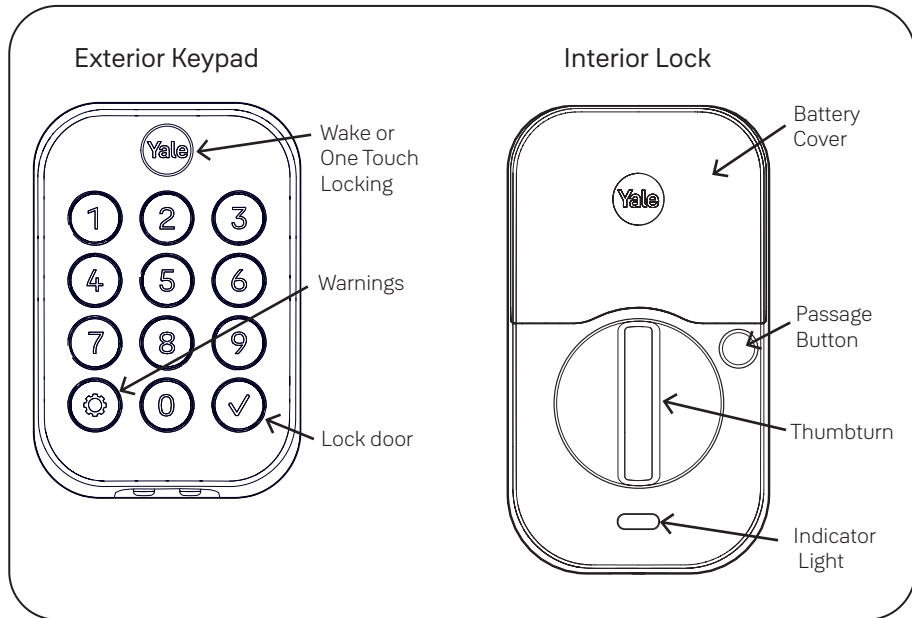



## Using Your Lock





# Features

Feature	Description
 DoorSense	<ul style="list-style-type: none"><li>• DoorSense tells you if your door is closed or open. Note: You can only ask a Voice Assistant if the door is locked or unlocked.</li></ul>
 Entry Codes	<ul style="list-style-type: none"><li>• Entry Codes are used to unlock your door.</li><li>• Create entry codes from the “Guest List” screen in our app.</li><li>• You can set the entry code to work permanently, recurring, or on a temporary schedule.</li><li>• An unlimited number of entry codes can be created or deleted at any time.</li></ul>
 Auto-Lock	<ul style="list-style-type: none"><li>• Auto-Lock automatically locks your door for you.</li><li>• It can be set to lock on a timer, as short as 30 seconds, or as long as 30 minutes.</li><li>• When using the Auto-Lock feature with the DoorSense, your door will not lock until it is in the closed position.</li><li>• Auto-Lock can be set up in the lock settings of the app.</li></ul>
 Auto-Unlock	<ul style="list-style-type: none"><li>• Auto-Unlock knows when you arrive and unlocks the door as you approach.</li><li>• Auto-Unlock can be set up in the lock settings of the app.</li></ul>
 Passage Mode	<ul style="list-style-type: none"><li>• Use passage mode when you want to disable Auto-Lock for an extended period of time. Simply press the button on the inside of the lock to turn it on.</li><li>• To turn passage mode off, simply lock your door.</li></ul>
 Integrations	<ul style="list-style-type: none"><li>• Yale Access products work in harmony with some of your favorite smart home brands to make life more simple and secure.</li><li>• Integrations can be set up in the Yale Access App from the “Works With” screen.</li></ul>



# Setting Definitions

Setting	Default	Definition
<b>Codes</b>		
Programming Code	Automatically created by the Yale Access App	This code is used to access programming features: Handing, Smart Module integration, and Diagnostics. This code cannot be used to unlock the door. Find your programming code in the Yale Access App, enter this code on the keypad and press the gear symbol.
Entry Codes		Entry codes can be created, from the Yale Access App, for users to allow them to lock/unlock the door from the lock keypad.
<b>Security Settings</b>		
Hide Entry Codes	Off	If turned on, all entry codes within the app will be hidden from view.
Verified Access	Off	If turned on, biometric/passcode authentication is required from the app to operate the lock.
<b>Notifications</b>		
Smart Alerts	Off	Create alerts you wish to receive from the app.
<b>Automation</b>		
Auto-Lock	Off	Door will automatically lock, either when door is closed (with DoorSense), or based on a timer.
Auto-Unlock	Off	Door will automatically unlock when you arrive home.
DoorSense	Must be installed	Allows you to know when your door is opened or closed.





# Setting Definitions

Setting	Default	Definition
<b>Advanced Device Settings</b>		
Volume	On	This feature can be changed in the Yale Access App. You can turn the lock volume on or off.
<b>Operating Mode:</b> Normal	On	When the lock is in normal operating mode all entry codes will work and the lock can be unlocked/locked from the app and voice assistants.
<b>Operating Mode:</b> Vacation	Off	This feature can be enabled in the Yale Access App. When enabled all entry code access will be restricted. Users can still lock and unlock the door with the app.
Inside Indicator Light	Off	This feature can be enabled in the Yale access App. When turned on, it will show the active status (locked) of the lock. This light will also inform you when the batteries are low, passage mode is enabled, and successful pairing.
<b>Keypad Security:</b> Wrong Code Limit	5 times	After five unsuccessful attempts at entering a valid entry code, the lock will shut down and not allow operation for sixty seconds. This timing can be changed from the app from 3 to 10.
<b>Keypad Security:</b> Shutdown Timing	60 seconds	The lock will shutdown for sixty seconds and not allow operation after the wrong code entry limit (3 attempts) has been made. This timing can be changed between 10 seconds to 3 minutes in the app.
One Touch Locking	On	Lock the keypad by touching the Yale logo.
Passage Button	Off	The passage button can be used to temporarily turn off auto-lock, so you can easily come and go without needing to unlock your door each time. To turn on passage mode, press the passage button on the inside of the lock. To turn off passage mode, simply lock your door.



# Troubleshooting

Symptom	Suggested Action
Lock does not respond - door is open and accessible.	<ul style="list-style-type: none"><li>• Keypad becomes active when the Yale logo is pressed.</li><li>• Verify contact with the logo.</li><li>• If keypad numbers are visible, check they respond when pressed.</li><li>• Check batteries are installed and oriented correctly (polarity) in battery case. Replace batteries* if dead.</li><li>• Check to ensure keypad wire is fully connected and not pinched.</li></ul>
Lock does not respond - door is locked and inaccessible.	<ul style="list-style-type: none"><li>• Batteries may not have enough power. Replace batteries*.</li><li>• Use mechanical key to unlock the door.</li></ul>
Lock is on for a while then shows no reaction. Lights dim.	<ul style="list-style-type: none"><li>• Batteries do not have enough power. Replace batteries*.</li></ul>
Lock chimes indicating code acceptance, but door will not open.	<ul style="list-style-type: none"><li>• Check for any foreign objects between door and frame.</li><li>• Check that the wire is firmly connected to inside lock.</li></ul>
Lock operates to allow access, but will not automatically unlock.	<ul style="list-style-type: none"><li>• Check to see if Auto-Lock is enabled.</li><li>• Disable Auto-Lock to lock the door (manually).</li></ul>
Lock responds "Low Battery".	<ul style="list-style-type: none"><li>• This is the alert to replace the batteries. Replace all four (4) batteries* with new AA Alkaline batteries.</li></ul>

\*When batteries are replaced, Smart Module locks have a real time clock that will be set through the User Interface.  
*It is recommended to verify correct date and time; particularly those locks operating under Daylight Savings Time.*



# Troubleshooting

Symptom	Suggested Action
Entry code will not register.	<ul style="list-style-type: none"><li>• If low battery indicator is lit, change batteries*.</li><li>• Entry code must consist of 4 to 8 digits.</li><li>• The same entry code cannot be used for multiple users.</li><li>• Entry code must be entered within 5 seconds (while keypad is active) or process will have to be restarted.</li></ul>
Upon entering an entry code and pressing the check key, the lock displays "invalid code" error or lock times out without responding.	<ul style="list-style-type: none"><li>• Verify entered code is a valid, previously programmed, 4 to 8 digit code.</li><li>• Vacation mode is on. Only an admin user can change vacation mode. Contact the admin.</li></ul>
Upon entering an entry code and pressing the check key, lock responds "Wrong number of digits".	<ul style="list-style-type: none"><li>• The digits entered were incorrect or incomplete. Re-enter the correct code followed by the check key.</li></ul>
Deadbolt does not extend when locking the door with keypad.	<ul style="list-style-type: none"><li>• Lock was not handed properly. Rehand lock through Settings Menu.</li></ul>
Lock operates, but makes no sound.	<ul style="list-style-type: none"><li>• Check in the Yale Access App to see if Volume is set to off.</li></ul>

\*When batteries are replaced, Smart Module locks have a real time clock that will be set through the User Interface. *It is recommended to verify correct date and time; particularly those locks operating under Daylight Savings Time.*

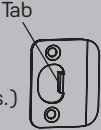

## Hardware Troubleshooting

Symptom	Solution
Deadbolt grinds and will not extend to lock when using an entry code but thumbturn locks and unlocks smoothly.	Attempt re-handing using the Settings Menu. You must use Programming Code to access the Settings Menu.
Deadbolt is hitting the strike plate.	Reposition the strike plate to align with deadbolt.
Deadbolt is not fully extending.	Increase depth of the deadbolt strike pocket in frame.
Resistance when locking deadbolt that requires pushing or pulling on the door to align deadbolt and latch.	<p>Adjust your existing knob, lever or handleset strike plate. Latch engagement into the strike is the main component used for door alignment.</p> <p>To adjust Knob/Lever/Handleset strike plate:</p> <ol style="list-style-type: none"><li>1. Remove plate from door frame with a hand screwdriver. (Using an electric driver may strip screw heads or enlarge screw holes.)</li><li>2. Locate tab on strike plate. Bend the tab towards surface of strike. Note: A small change may be all that is required.</li><li>3. Reinstall strike plate using a screwdriver and test again.</li><li>4. If door cannot be adjusted sufficiently with strike tab, both knob/lever/handleset latch and deadbolt could require adjustment – we suggest you contact a local locksmith for assistance.</li></ol> <p>For help with misalignments, watch our door alignment video: <a href="https://US.YaleHome.com/Support">US.YaleHome.com/Support</a></p> 



## Resetting Lock to Factory Defaults

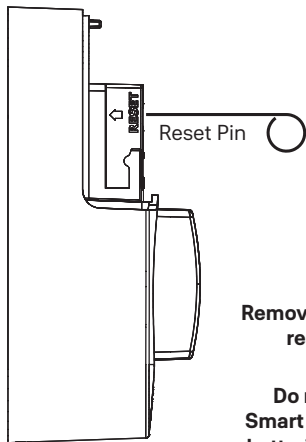

Interior Lock

When lock is reset\*, it will remove the lock from the Yale Access App and remove all pin codes and settings that were changed.

### To Reset Lock:

1. Remove battery cover and one battery.
2. Press reset button for 1 minute with the reset tool provided in the hardware box.
3. Replace cover.

**Note:** If the lock was enrolled in a Z-Wave network prior to reset, it will need to be set up again.

\*After reset, lock must be set up with the Yale Access App.



## Keypad Alerts

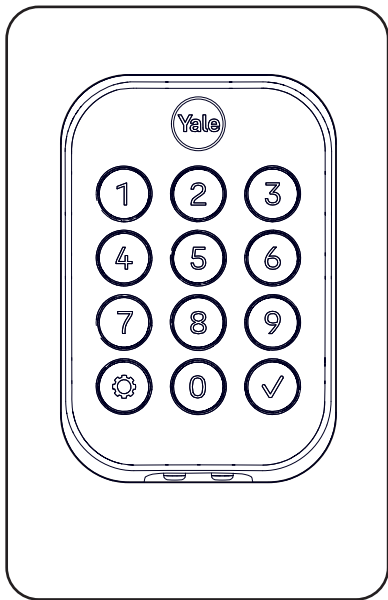

Keypad	Meaning
Gear flashes Amber	Low Battery Level 1
Gear flashes Red	Low Battery Level 2
Gear flashes Red then stays red until batteries are replaced	Low Battery Level 3
Checkmark flashes	Pairing Success
X then gear flashes Red	Jammed Lock
Gear flashes White	Pairing/successful pairing
Gear flashes Red during pairing	Failed Pair



## Interior Lock Light Alerts

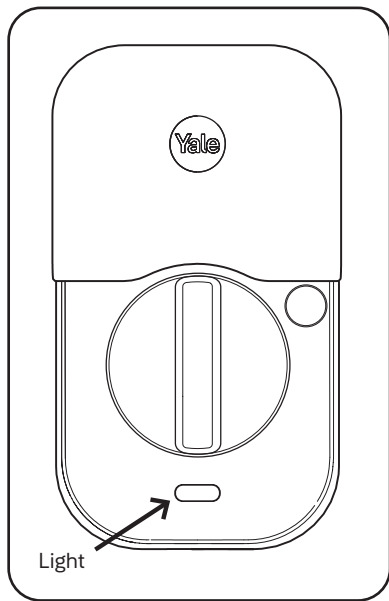

Inside Lock Light	Meaning
Blue flashing	Low Battery Level 1
Blue flashing	Low Battery Level 2
Blue flashing	Low Battery Level 3
Pink flashing	Passage Mode enabled
Red flash	Locked state
Green flash	Unlocked state
Green 3 second solid	Pairing Success
Red 3 second solid	Pairing Fail

**Use:**

Use of the Works with Apple badge means that an accessory has been designed to work specifically with the technology identified in the badge and has been certified by the developer to meet Apple performance standards.

Apple is not responsible for the operation of this device or its compliance with safety and regulatory standards.

Apple®, Apple Home™, Apple Watch®, HomeKit®, and iPhone® are trademarks of Apple Inc., registered in the U.S. and other countries and regions.

Google, Google Play and Google Home are trademarks of Google LLC.

Amazon, Alexa and all related logos are trademarks of Amazon.com, Inc. or its affiliates.

Wi-Fi is a registered trademark of Wi-Fi Alliance®.

The Bluetooth® word mark and logos are registered trademarks owned by Bluetooth SIG, Inc. and any use of such marks by [licensee name] is under license. Other trademarks and trade names are those of their respective owners.

**FCC:**

FCC ID: 2ABFG-YRD450BLEV1

IC ID: 11626A-YRD450BLEV1

Class B Equipment

This equipment has been tested and found to comply with the limits for a Class B digital device, pursuant to Part 15 of the FCC Rules. These limits are designed to provide reasonable protection against harmful interference in a residential installation. This equipment generates, uses, and can radiate radio frequency energy and, if not installed and used in accordance with the instructions, may cause harmful interference to radio communications. However, there is no guarantee that interference will not occur in a particular installation. If this equipment does cause harmful interference to radio or television reception, which can be determined by turning the equipment off and on, the user is encouraged to try to correct the interference by one or more of the following measures:

- Reorient or relocate the receiving antenna.
- Increase the separation between the equipment and receiver.
- Connect the equipment into an outlet on a circuit different from that to which the receiver is connected.
- Consult the dealer or an experienced radio/TV technician for help.

**Warning:**

Changes or modifications to this device, not expressly approved by **Yale Home** could void the user's authority to operate the equipment.

**Industry Canada:**

FCC ID: 2ABFG-YRD450BLEV1

IC ID: 11626A-YRD450BLEV1

This Class A digital apparatus meets all requirements of the Canadian Interference Causing Equipment Regulations.

## Yale Home

24/7 Support: 1-855-213-5841 • US.YaleHome.com

Yale® and Assure Lock® 2 are registered trademarks of Yale Home. Other products' brand names may be trademarks or registered trademarks of their respective owners and are mentioned for reference purposes only. ©Copyright 2022. All rights reserved. Reproduction in whole or in part without the express written permission of Yale Home is prohibited.