



# qubino®

Your little magic for the smartest home.

## USER MANUAL **EN**

---

### QUBINO FLUSH DIMMER 0-10V

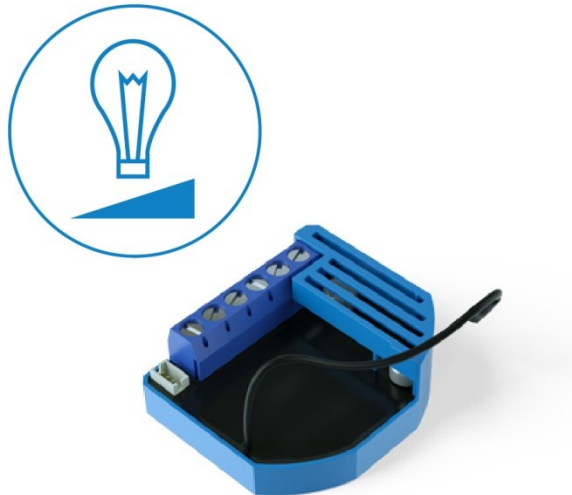

*Flush Dimmer 0-10V is a universal dimmer with a standard 0-10V output and a multi-function input.*

# Table of contents

---

Safety Information .....	5
Flush Dimmer 0-10V - Available Frequencies .....	6
Where To Buy.....	7
1. Introduction .....	7
2. Use Cases .....	9
2.1. Installation examples where Flush Dimmer 0-10V is installed behind a wall switch .....	9
2.2. Additional features of Flush Dimmer 0-10V which can make your life easier .....	11
3. Qubino Flush Dimmer 0-10V Advantages and Highlights .....	12
3.1. Advantages .....	12
3.2. Highlights .....	15
4. Package Contents.....	16
5. Technical Terms for Switches.....	17
6. Compatibility with Z-Wave Gateways (hubs).....	18
7. Installation .....	19
7.1. Installing the device behind a light switch .....	20
7.2. Installing the Qubino Temperature Sensor .....	26
8. Device Information and Support.....	32
9. Electrical Diagram (12 - 24VDC).....	33
10. Adding the device to a Z-Wave network (Inclusion).....	34
11. Removing the device from a Z-Wave network (Exclusion) .....	35
12. Associations .....	36
13. Configuration Parameters.....	37
14. Technical Specifications .....	49
15. Z-Wave Command Classes .....	50
16. Important Disclaimer .....	53
17. Warning.....	53
18. Regulations.....	53



**About Z-Wave:**

The Z-Wave protocol is an interoperable, wireless, RF-based communications technology designed specifically for control, monitoring, and status reading applications in residential and light commercial environments. Mature, proven, and broadly deployed (with over 50 million products sold worldwide), Z-Wave is by far the world market leader in wireless control, bringing affordable, reliable, and easy-to-use 'smart' products to millions of people in every aspect of daily life.

Source: [www.z-wavealliance.org](http://www.z-wavealliance.org)

## Safety Information

For Qubino, safety is first, so we have prepared lots of safety tips and information that can be found throughout this manual.

**To ensure your safety, please read this manual carefully before installing the device; follow the instructions exactly.** The manufacturer (GOAP d.o.o. Nova Gorica) shall not be legally responsible for any equipment damage or personal injury caused by incorrect installation or operation other than that covered in this manual.

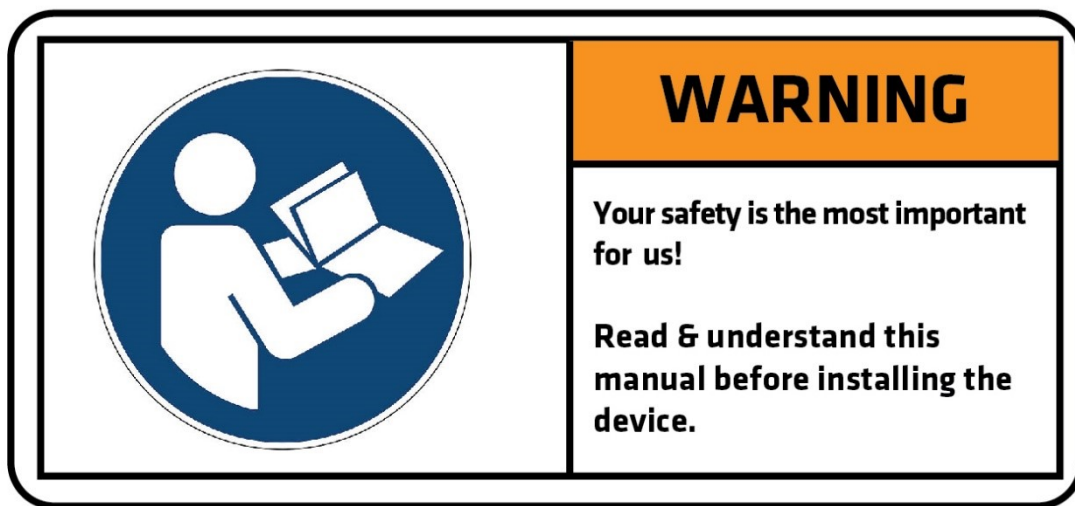

**i** Please check the Technical Specifications and Electrical Diagram chapters, as well as fuse requirements in the Installation chapter before installing the device.

## Flush Dimmer 0-10V - Available Frequencies

ORDERING CODE (MODEL NUMBER)	Z-WAVE FREQUENCY*
ZMNHVD1	868,4 MHz
ZMNHVD2	921,4 MHz
ZMNHVD3	908,4 MHz
ZMNHVD4	869,0 MHz
ZMNHVD5	916,0 MHz
ZMNHVD6	868,4 MHz
ZMNHVD7	919,8 MHz
ZMNHVD8	865,2 MHz
ZMNHVD9	922,5 MHz
ZMNHVDA	919,7 – 921,7 – 923,7 MHz
ZMNHVDB	868,1 MHz
ZMNHVDC	868,1 MHz
ZMNHVDD	919,8 MHz
ZMNHVDE	920,9 MHz

\*You can check the Z-Wave frequency in your country here:

<https://www.silabs.com/products/wireless/mesh-networking/z-wave/benefits/technology/global-regions?cid=nat-acq-zwv-041818>

# Where To Buy

To find your nearest Qubino dealer visit: <http://qubino.com/where-to-buy/>

## 1. Introduction

Flush Dimmer 0-10V is a universal dimmer with a standard 0-10V output and a multi-function input. It can be paired with a digital temperature sensor (sold separately). It supports push-button/momentary switches, toggle switches (default), potentiometers, and 0-10V inputs (requires external source).



The connection of a digital temperature sensor means you can create complex scenes and control any device relative to a set temperature range. The Qubino Flush Dimmer 0-10V also acts as a Z-Wave repeater to improve the range and stability of the Z-Wave network.

**Flush Dimmer 0-10V supported functions:**

Dim the Lights	Turn On/Off	Temperature Sensor	Automatically turn ON/OFF	Associations	Z-Wave Repeater	Auto-inclusion
✓	✓	✓	✓	✓	✓	✓





## 2. Use Cases

The Flush Dimmer 0-10V can be used in many different scenes, which can help make your life more comfortable. We have prepared a few of them for you-so you can get an idea for your next smart home project. Of course, there are countless of other options for how to use Qubino Flush Dimmer 0-10V to remotely control devices via your smartphone.

### 2.1. Installation examples where Flush Dimmer 0-10V is installed behind a wall switch

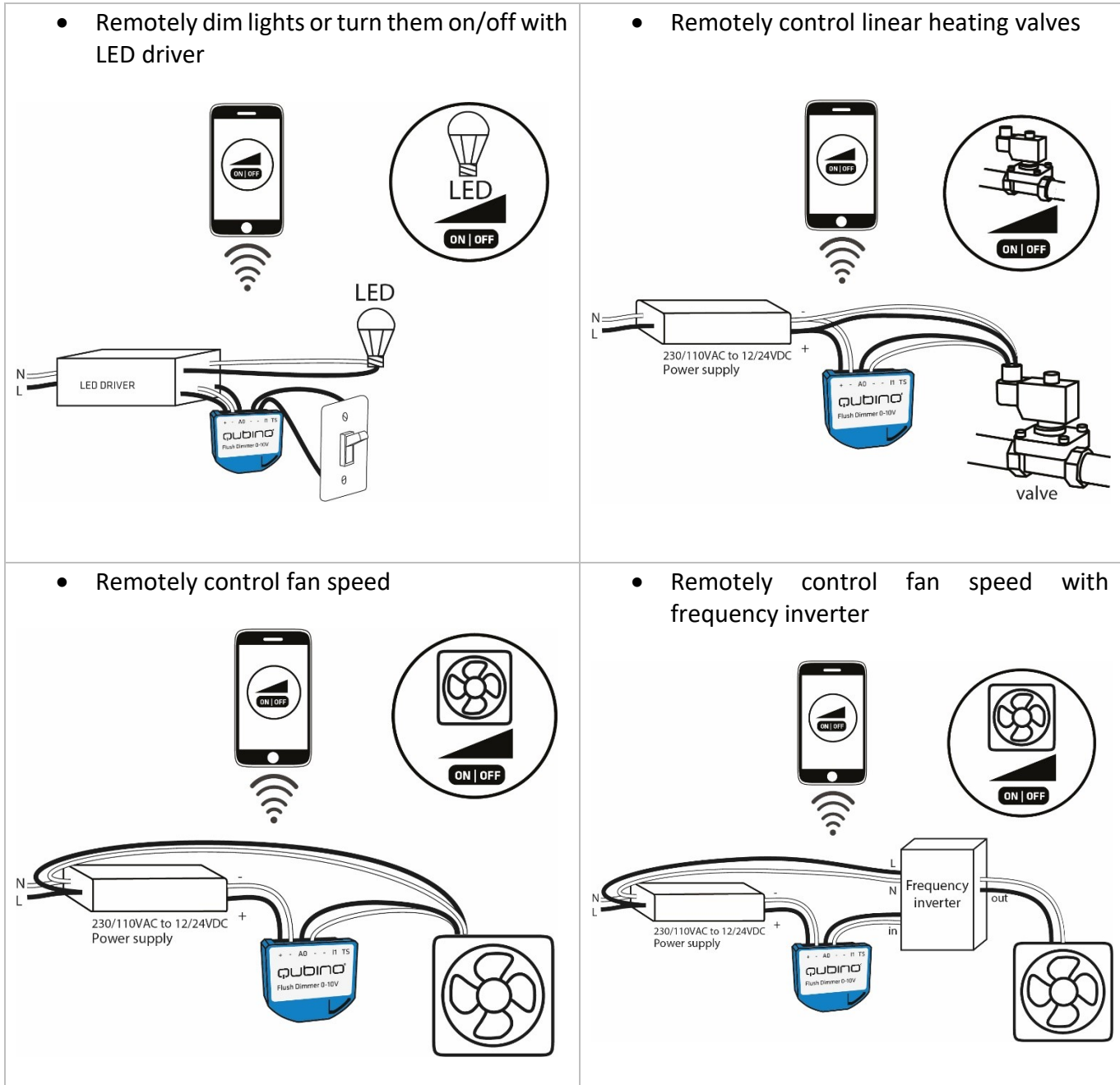

- Automatic illumination control (with connected lux sensor with 0-10V output)

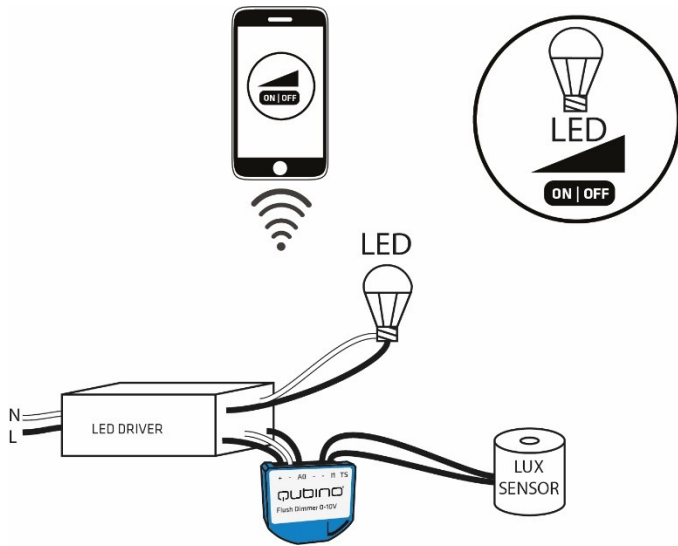

- Automatic heat valve control (with connected temperature sensor with 0-10V output)

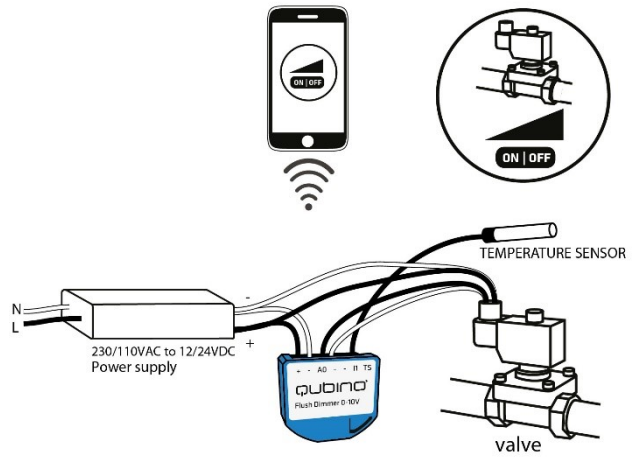

## 2.2. Additional features of Flush Dimmer 0-10V which can make your life easier

- Do you often forget to turn off devices when you leave your home, like lights in the basement or attic?
- The Flush Dimmer 0-10V can automatically turn devices/lights on or off after a set period of time (when you're away from home). For example, the light will automatically turn off if it's been on for 8 hours, let's say. This function is independent of other scenes and gateway (hub) commands.

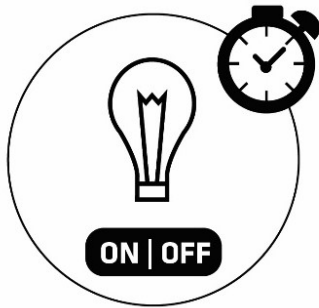

- Want to control other devices in your Z-Wave network with the Flush Dimmer 0-10V?
- Connect the Flush Dimmer 0-10V with other devices in your network to remotely and automatically trigger another Z-Wave device. And have other Z-Wave devices trigger your Qubino Flush Dimmer 0-10V.



- Remotely measure room temperature (\*The temperature sensor is sold separately - for more info, please see Qubino catalogue. Product ordering code (model number): ZMNHEA1)

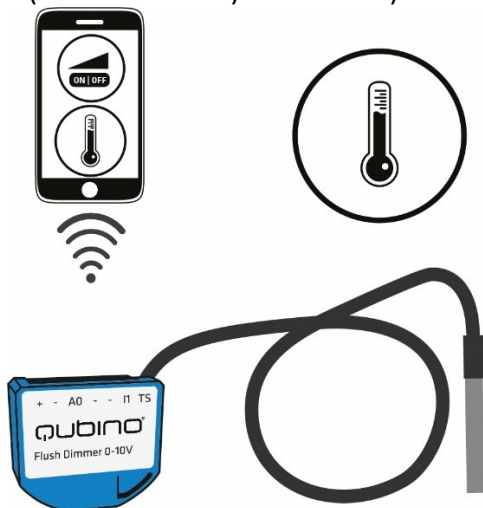

### 3. Qubino Flush Dimmer 0-10V Advantages and Highlights

#### 3.1. Advantages

- The Qubino Flush Dimmer 0-10V allows the **easiest and quickest installation possible**. Because of its small size, it allows a smooth installation even in cases where there are lots of electrical cables and where **every millimetre counts**. All this is possible because the Qubino Flush Dimmer 0-10V is **the smallest Z-Wave dimmer in the world**.

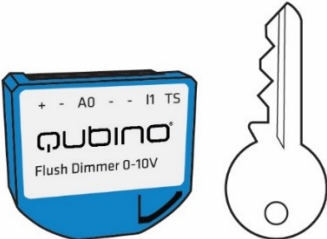

- The Qubino Flush Dimmer 0-10V has the **option to connect a temperature sensor\***, through which users can monitor the ambient air or water temperature. It's the only Z-Wave dimmer in the world which offers this option. With a connected sensor, the user can monitor accurate measurements of the room temperature, pool water temperature, etc., and remotely change conditions as desired. Qubino dimmer, along with the temperature sensor, is connected directly to the power supply. Install it and forget it – no need to worry about dying batteries, like with battery-powered sensors.

\*The temperature sensor is sold separately - for more info, please see Qubino catalogue. Product ordering code (model number): ZMNHEA1



**i** Please do not put the temperature sensor directly into the water! The temperature sensor is designed to measure the water temperature by being mounted to the water pipe.

- Qubino guarantees **100% device quality**. Such high quality can be delivered because every Qubino goes through rigorous quality control standards throughout the production process. Every device has a unique serial number and a part number, which are assigned to the device only after it goes through a strict testing procedure.



- By scanning the QR code on the back of your Qubino device, the serial and part numbers will be automatically copied on your mobile phone; they also provide **direct access to Qubino's technical support team**. The serial and part numbers of your device are given automatically every time you open an inquiry with our support team: this instantly shares the relevant device information we need to provide the best technical support possible. For details, please see the Device Information and Support chapter.



- The Qubino Flush Dimmer 0-10V is **engineered and manufactured in the EU**, and contains only the highest quality components.



- The Qubino Flush Dimmer 0-10V is certified by an independent European Institute and has CE, FCC, LVD and EMC certificates to ensure the highest safety standards.

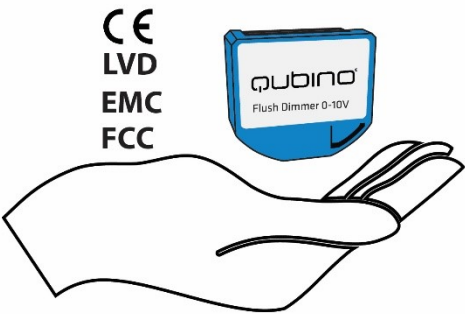

### 3.2. Highlights

- Remote (via smartphone or PC) and local on/off control of ALL dimmable bulbs using LED drivers with input 0-10V
- Works with push-button (momentary switch) and toggle switch or Potentiometer you can install it behind power sockets
- Features one of the easiest and quickest installations of devices of this kind
- Saves and restores the last status after a power failure
- Supports auto-inclusion mode for quick set up
- Can automatically turn devices on and off after a set period of time (helpful when you're away from home, for example) \*
- Supports additional parameters for expert users, which allows for advanced configuration\*
- Acts as a signal repeater which improves the range and stability of your Z-Wave network
- Can be used to remotely control and trigger other devices in your Z-Wave network







\*Your gateway (hub) needs to support advanced configuration and parameter input if you wish to use this feature

## 4. Package Contents

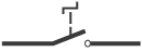
- Flush Dimmer 0-10V Device
- Installation Manual

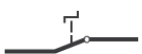
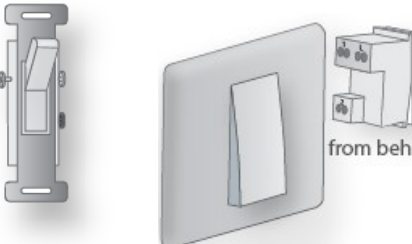

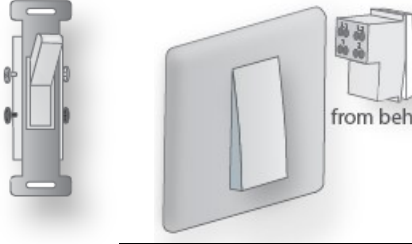
## 5. Technical Terms for Switches

Symbol	Switch example images	Definition	EU	USA	Qubino	Other names
		Single pole, single throw (SPST) - One switch controlling one light / circuit of lights	One-way switch	Two-way switch (regular switch)	Toggle switch	Switch; Bi-stable switch
		Single pole, double throw (SPDT) - Two switches controlling the same light / circuit of lights	Two-way switch	Three-way switch	Two-way switch	
		Used when you have three or more switches controlling the same light	Intermediate switch	Four-way switch	Intermediate switch	Crossover switch; Cross connection
		After being released, it goes back to its original state	Momentary switch		Momentary switch	Monostable switch; Push button

## 6. Compatibility with Z-Wave Gateways (hubs)

Please check compatibility with your Z-Wave gateway (hub) before you purchase this device. The compatibility table is available online.

[https://qubino.com/manuals/Compatibility\\_with\\_gateways/Compatibility\\_manual\\_Flush\\_Dimmer\\_0-10V.pdf](https://qubino.com/manuals/Compatibility_with_gateways/Compatibility_manual_Flush_Dimmer_0-10V.pdf)

## 7. Installation

**Before installing the device, please read the following carefully and follow the instructions exactly:**

**ⓘ Danger of electrocution!**

Installation of this device requires a great degree of skill and may be performed only by a licensed and qualified electrician. Please keep in mind that even when the device is turned off, voltage may still be present in the device's terminals.

**ⓘ Note!**

Do not connect the device to loads exceeding the recommended values. Connect the device exactly as shown in the provided diagrams. Improper wiring may be dangerous and result in equipment damage.

**Electrical installation must be protected by directly associated overcurrent protection fuse F (ESKA 522.504 50mA 250V) according to Eletrical diagram.**

### 7.1. Installing the device behind a light switch

The installation process, tested and approved by professional electricians, consists of the following simple steps:

**Step 1 – Turn OFF the fuse:**

- To prevent electrical shock and/or equipment damage, disconnect electrical power at the main fuse or circuit breaker before installation and maintenance.
- Be aware that even if the circuit breaker is off, some voltage may remain in the wires — before proceeding with the installation, be sure no voltage is present in the wiring.
- Take extra precautions to avoid accidentally turning the device on during installation.

**STEP 1**

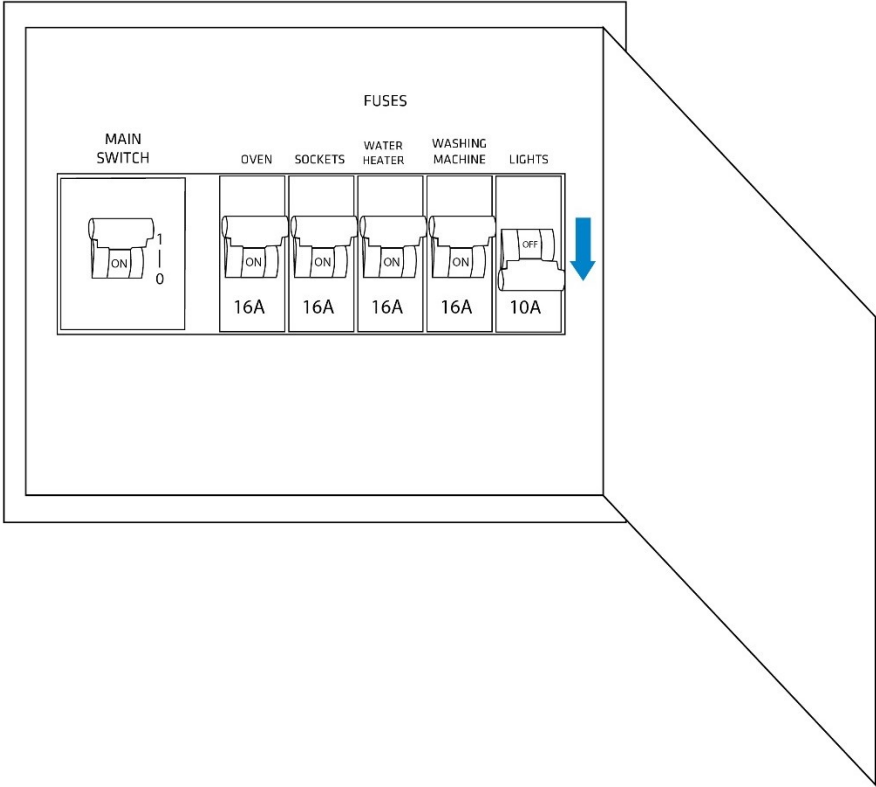

**Step 2 – Installing the device:**

- Connect the device exactly according to the diagrams shown below

**STEP 2**

**Before Qubino installation:**

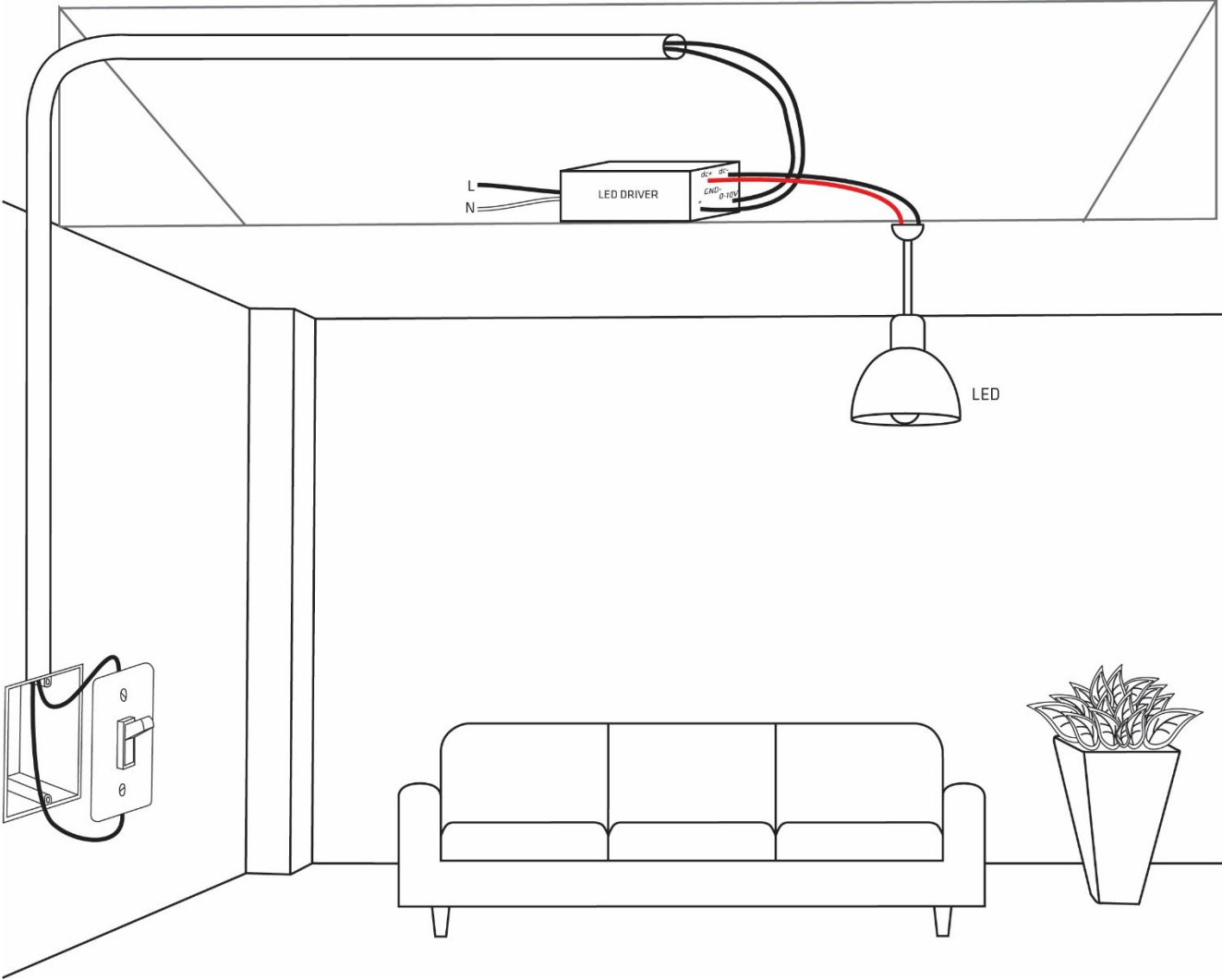

**After Qubino installation:**

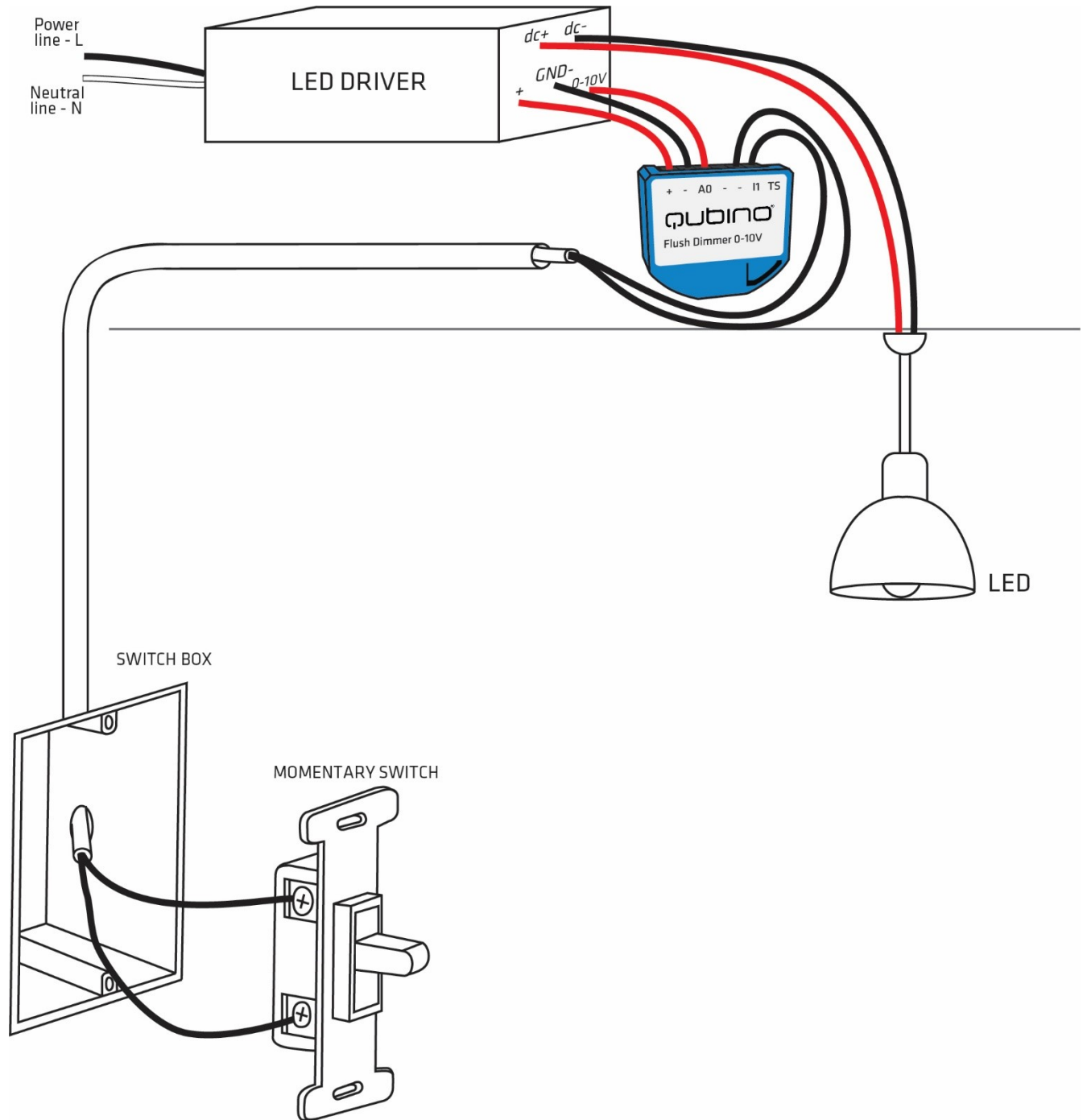

**Note!**

- Place the antenna as far as possible from metal elements as they may cause signal interference.
- Do not shorten the antenna.

The device’s antenna should be as upright as possible. This ensures the device’s operational range is maximized (up to 98 feet (30 m) line of sight).

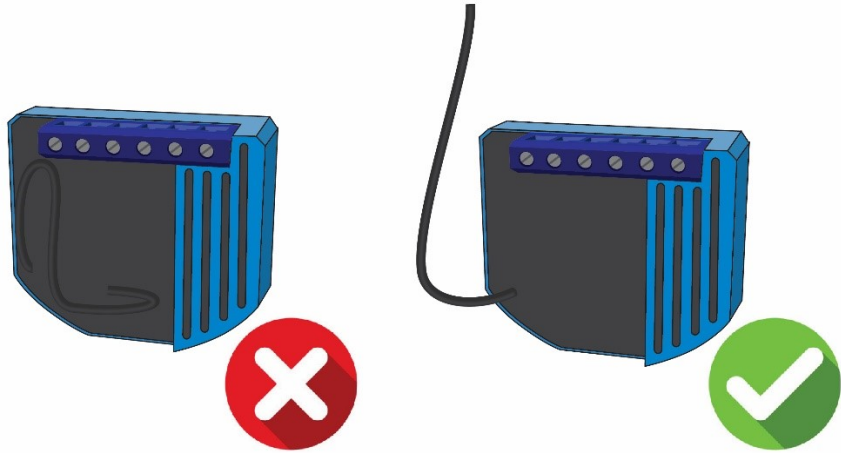

**Step 3 – Turn ON the fuse:**

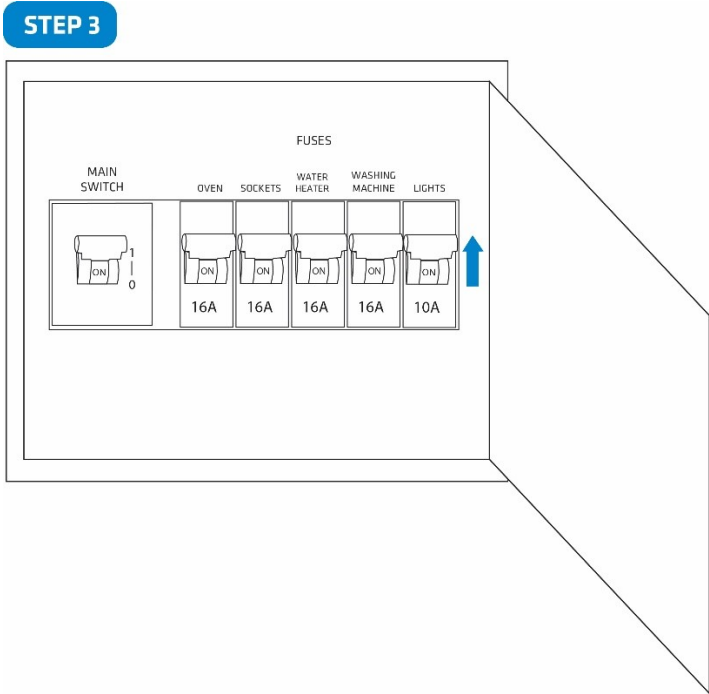

**Step 4 – Add the device to your Z-Wave network:**

- For more details on how to include the device, please refer to the Z-Wave Inclusion chapter.

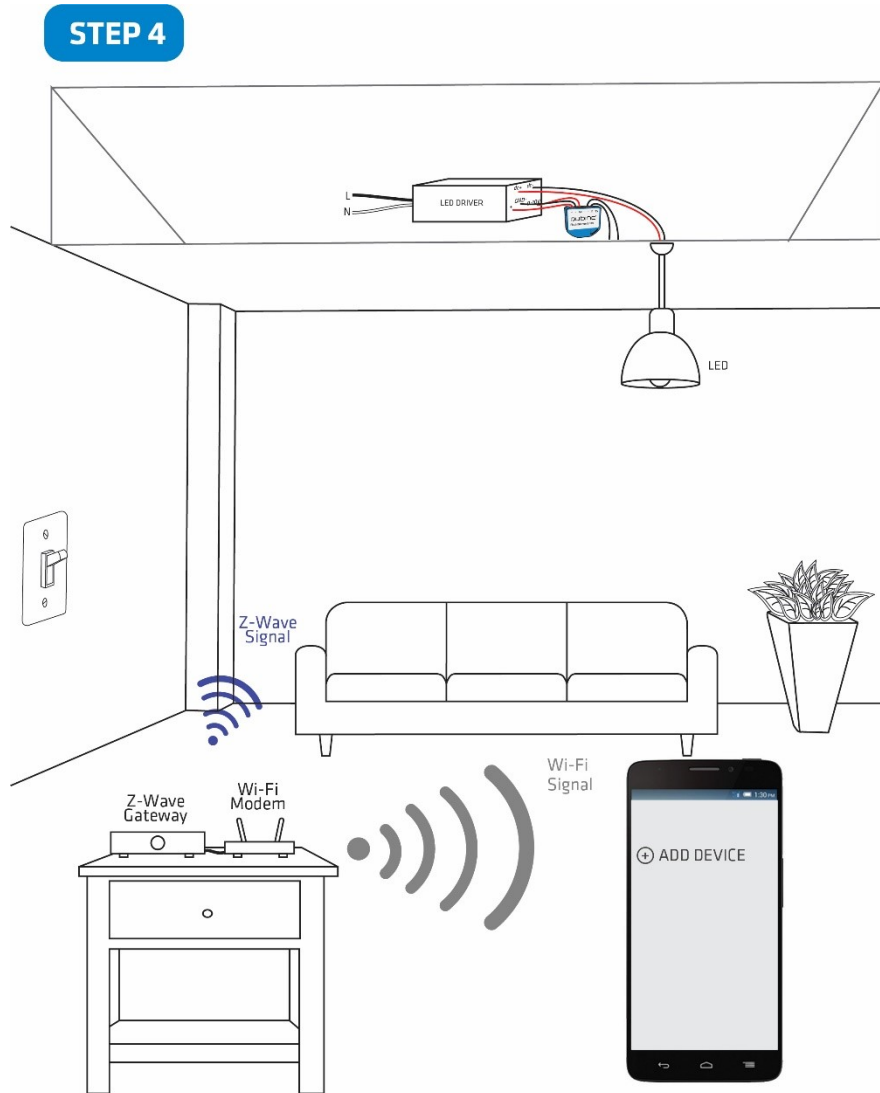



**Step 5 – The Installation is now complete. It’s time to make your life more comfortable with the help of the Qubino Flush Dimmer 0-10V**

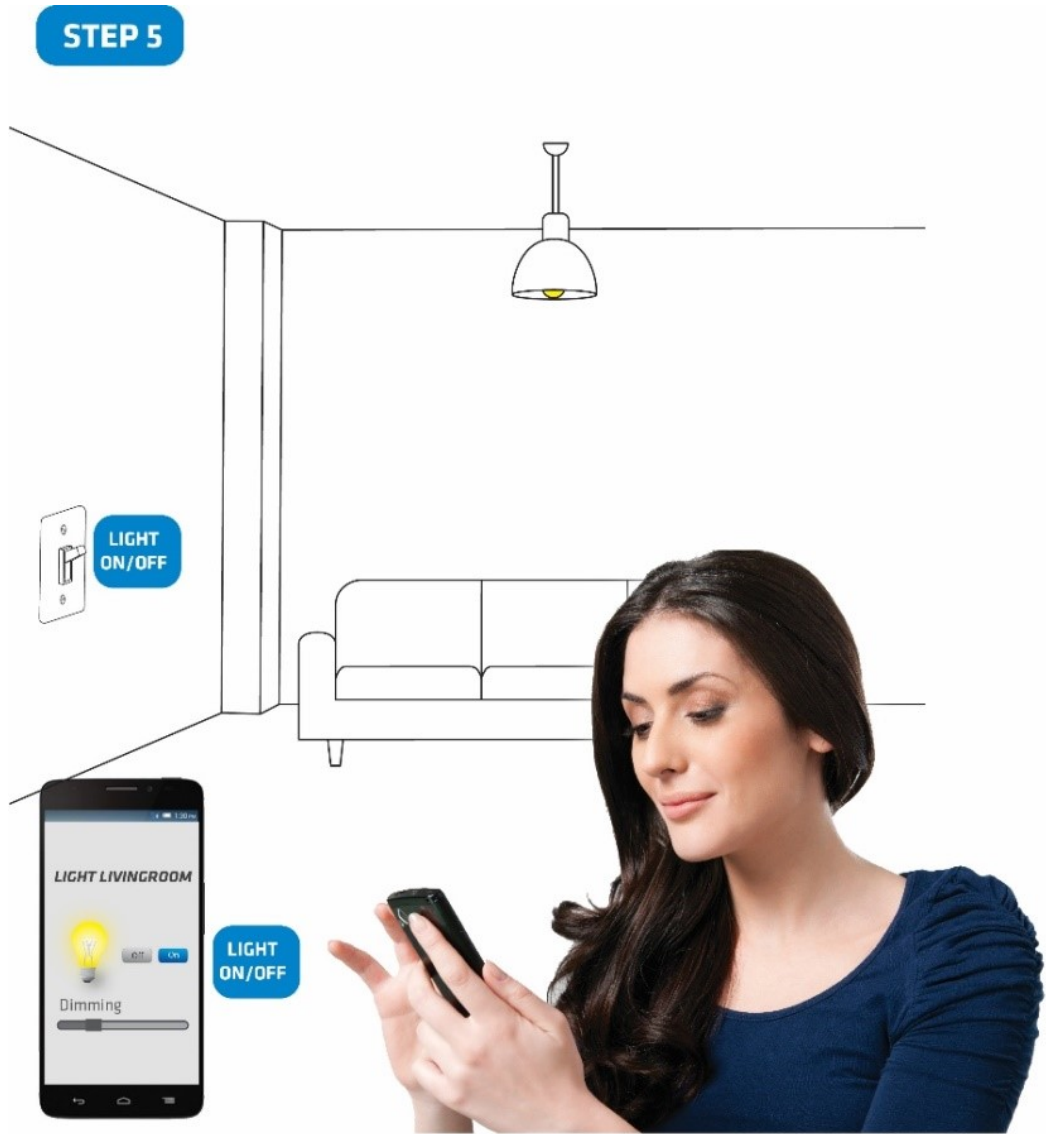

## 7.2. Installing the Qubino Temperature Sensor

The temperature sensor is a Qubino accessory and is sold separately - for more info, please see the Qubino product catalogue or website: <http://qubino.com/products/accessories/>

**Product ordering code: ZMNHEA1**

Qubino Z-Wave devices have the option to connect a temperature sensor (sold separately), which allows you to **remotely monitor ambient or water temperature**. Qubino devices are the only Z-Wave devices of its kind to offer this unique capability. With the sensor connected to the device, you can carry out accurate measurements of room temperature, pool water temperature, etc. and build automation rules around them. Qubino device with a temperature sensor is connected directly to power supply. Install it and forget it, there is no need to worry about changing the batteries like with most other Z-Wave temperature sensors which run on batteries. The temperature sensor's range is between  $-25 \sim +80^{\circ}\text{C}$  ( $-13 \sim 176^{\circ}\text{F}$ ).

For more details about the temperature range, see the manual for the temperature sensor below.

Qubino\_TemperatureSensor:

[https://qubino.com/manuals/Installation/Temperature\\_Sensor\\_manual.pdf](https://qubino.com/manuals/Installation/Temperature_Sensor_manual.pdf)

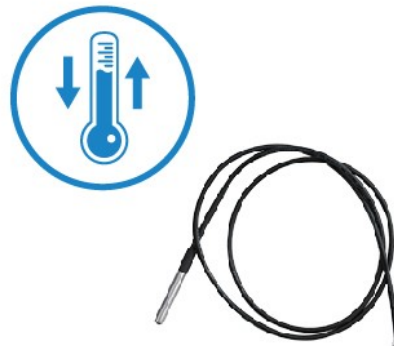

The digital Temperature sensor comes with a 1 m (3.3 ft) cord and a connector to attach it directly to a Qubino device.

1. To prevent electrical shock, make sure that no voltage is present on the temperature sensor cable.
2. When connected to Qubino device, the temperature sensor is under high voltage, which is very dangerous.
3. Goap d.o.o. does not take responsibility for any damage or electrical shock due to incorrect sensor assembly.
4. The above instructions and description apply to a temperature sensor compatible with Qubino products only.

### Temperature sensor installation example:

**Step 1 – Exclude the device (if it is already connected to your Z-Wave system)**

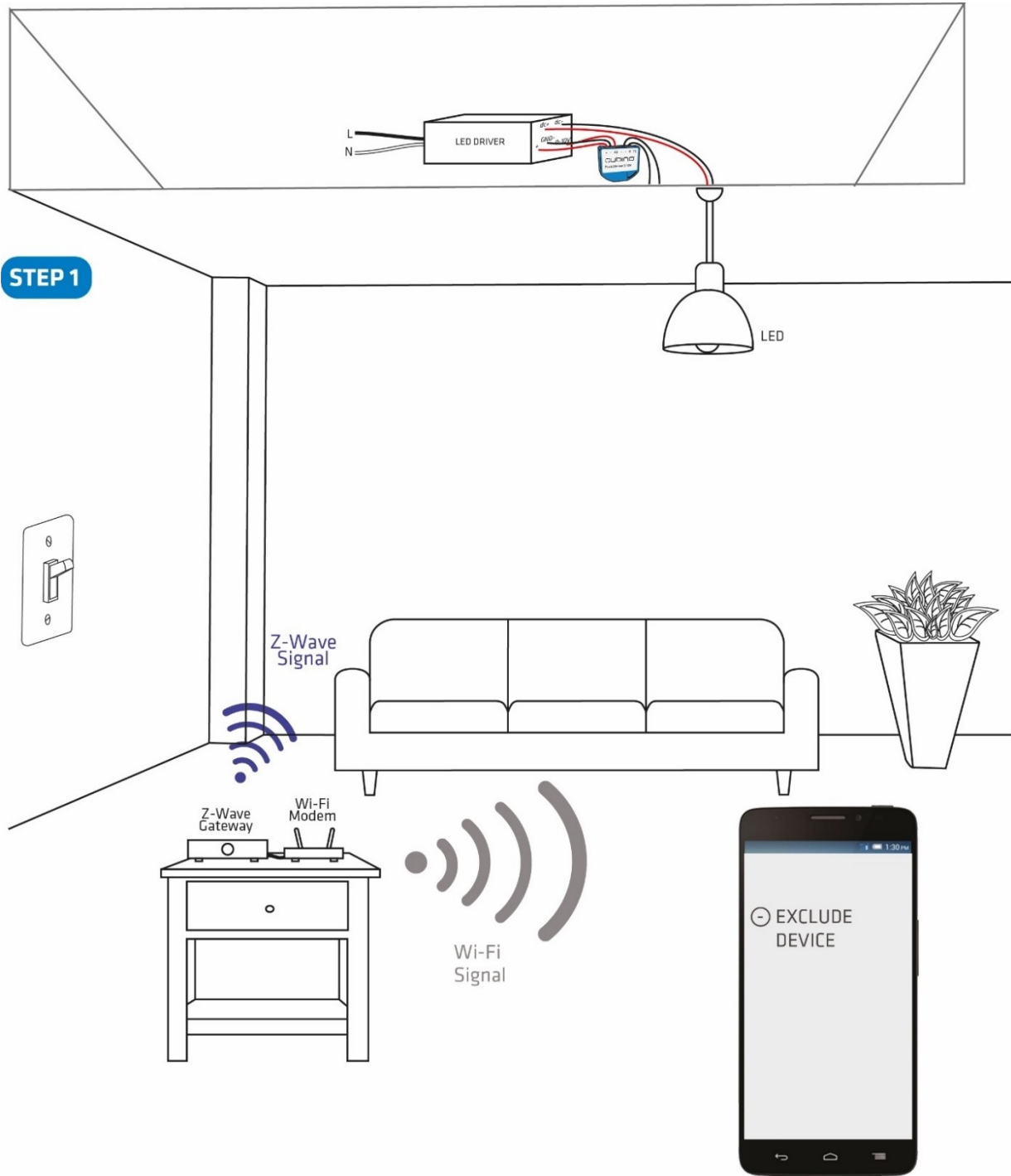

**Step 2 – Switch of the power supply**

**STEP 2**

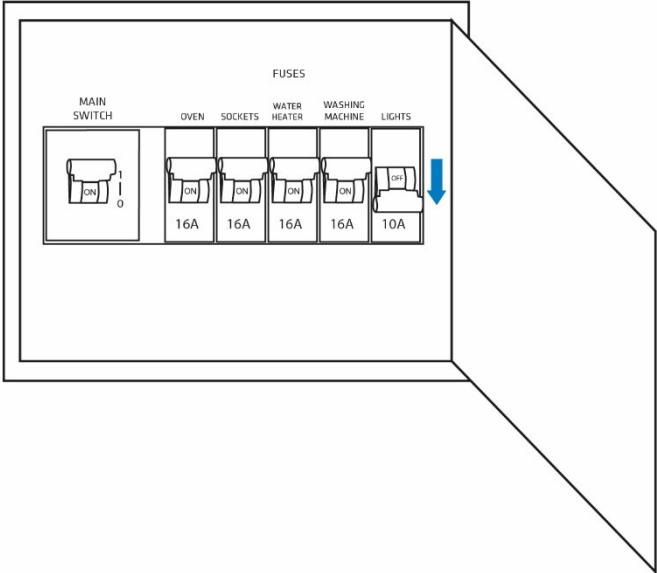

**Step 3 – Connect the temperature sensor as shown below**

**STEP 3**

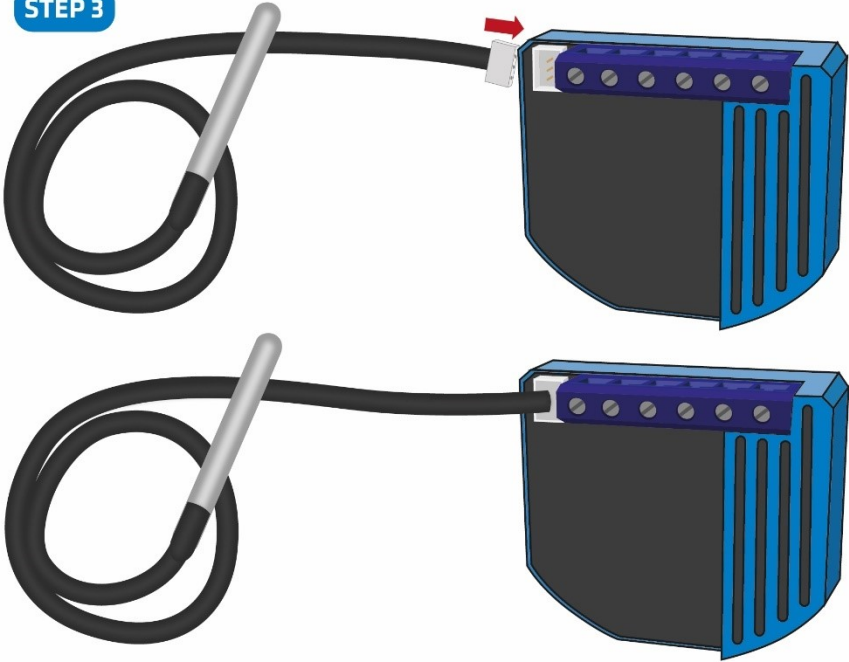

**Step 4: Place the temperature sensor**

**STEP 4**

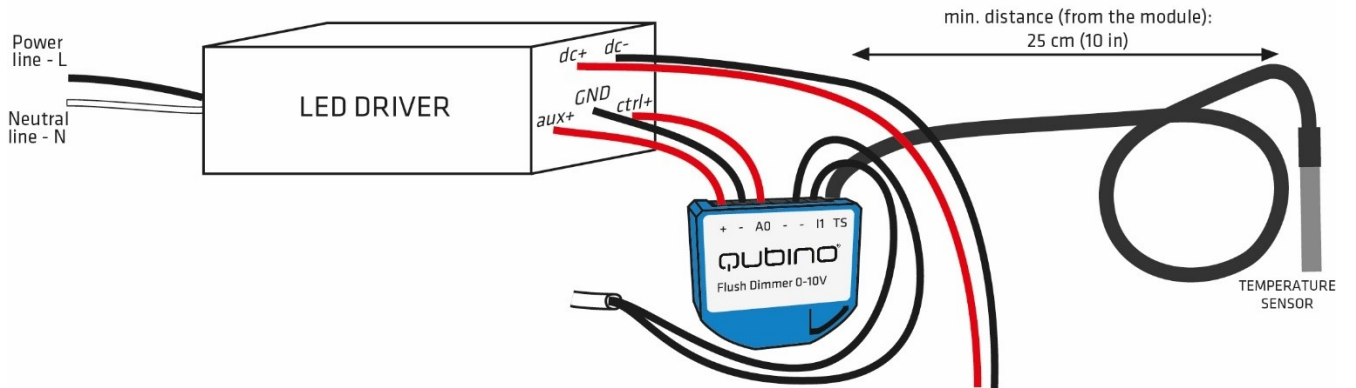

**Step 5 – Turn the fuse on**

**STEP 5**

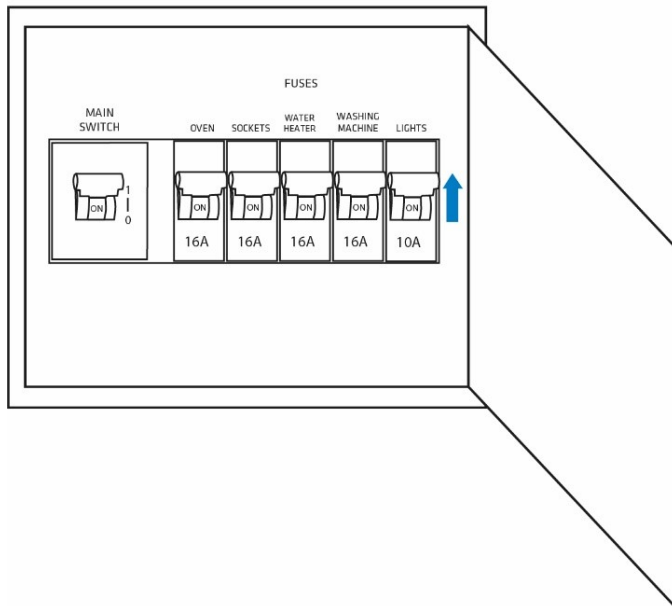

**Step 6 – Re-include the device to your network**

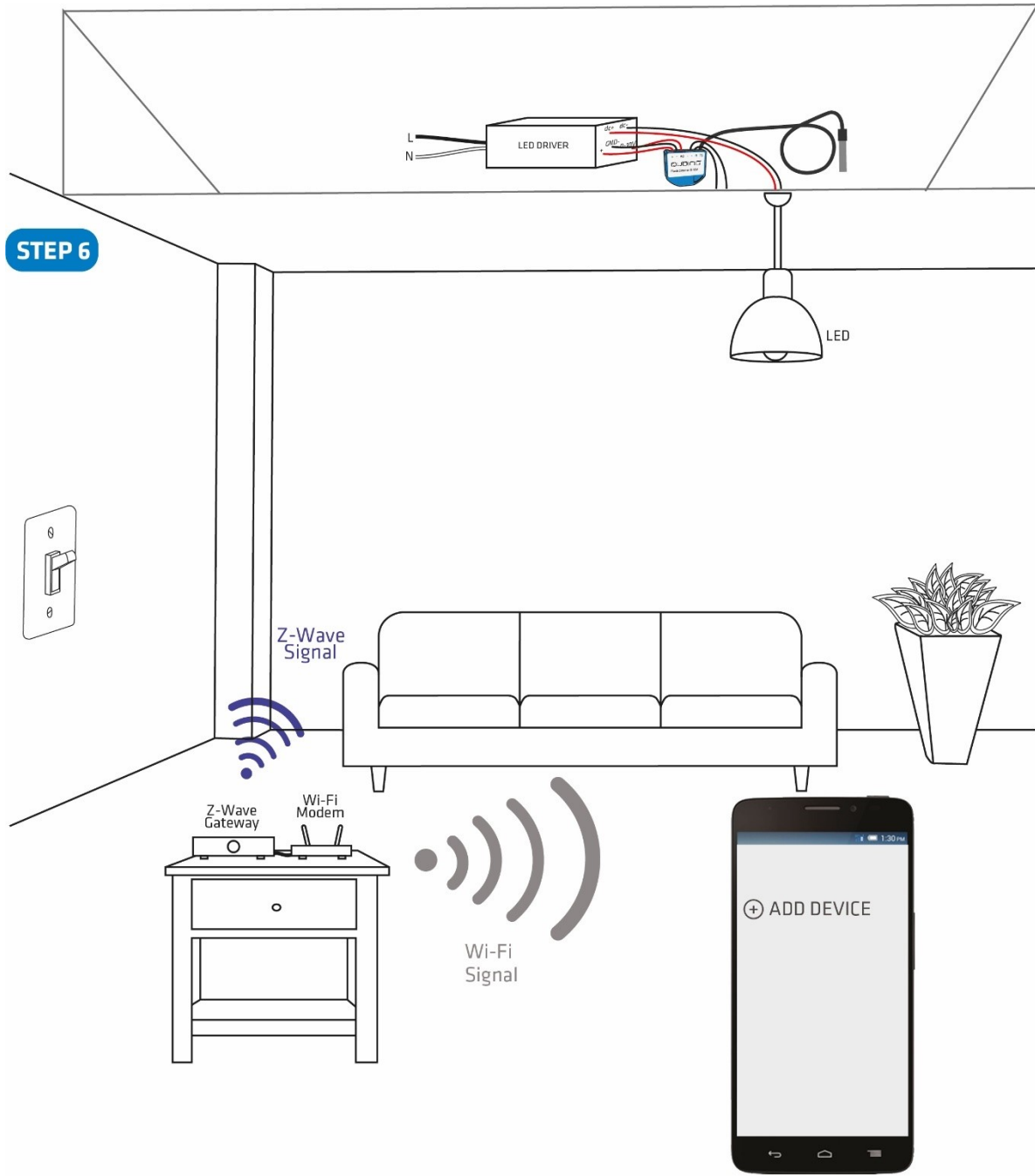

**Step 7 – Start using the temperature sensor in connection with your device**

STEP 7

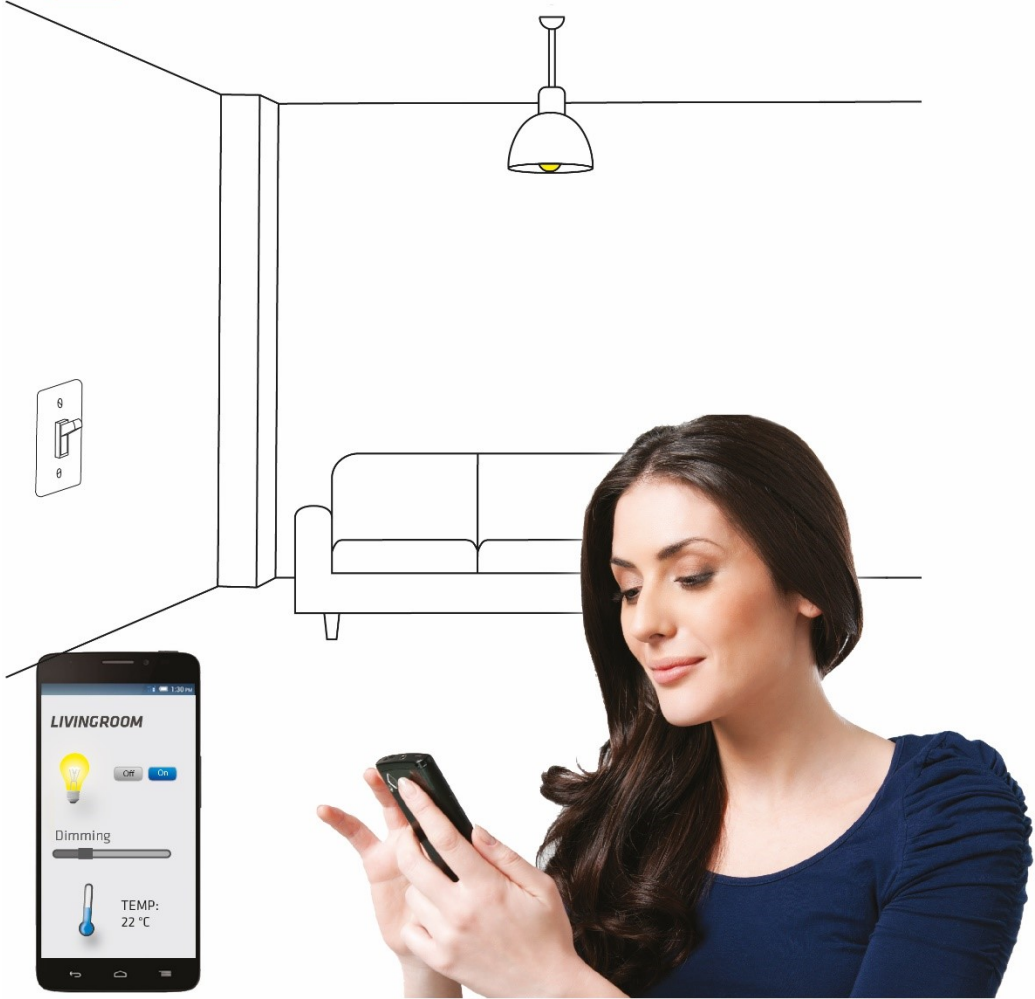

## 8. Device Information and Support

Did you know that Qubino offers Z-Wave devices with 100% quality control guaranteed throughout the production process? Every single unit is tested and examined before being approved for sale – a truly unique pledge in the industry.

### Why is this important?

Every device has a dedicated serial number and part number, which is assigned to the device only after it goes through a strict testing procedure.

By scanning the QR code on the back of your Qubino, its device title, serial number, and part number are automatically copied to your mobile phone. You can also use the code for direct access to the device page for more information. If you still don't find what you're looking for, click on the link to Qubino technical support team. They will be able to automatically read the serial and part number from your device and quickly review the production log file containing the production date as well as any relevant device parameters and information. This process allows our team to immediately identify and address issues, giving you the best support possible.

### GET SUPPORT IN 3 SIMPLE STEPS:



Based on customer and business partner feedback, we're proud to boast Qubino's support team as the best and fastest on the market. If you don't find the answers to your questions in this document, please contact our support team by scanning the QR code on your device or through our website: <https://qubino.com/support/#email>. We will try to help you as soon as possible.



# 9. Electrical Diagram (12 - 24VDC)

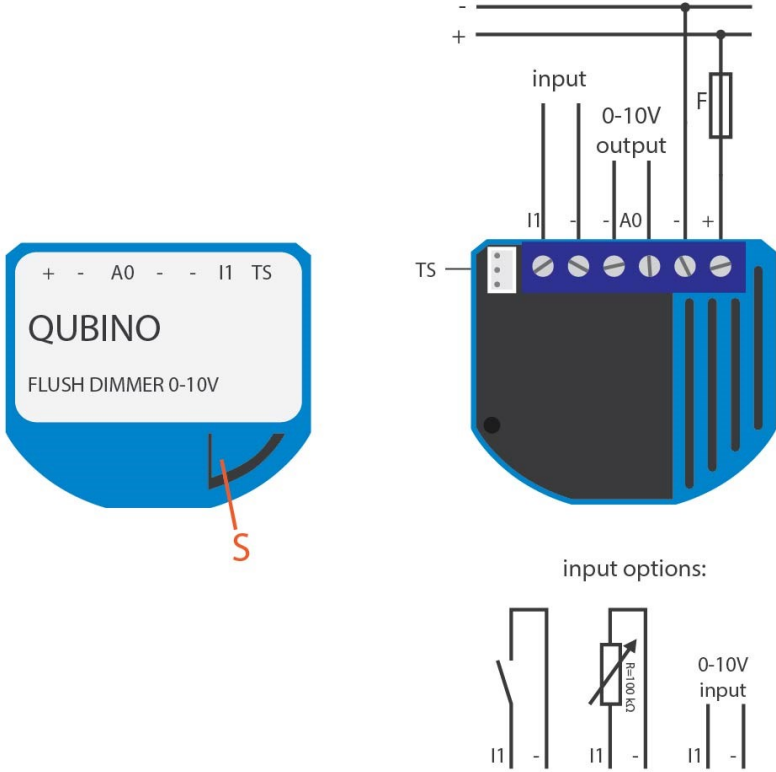

\*\*For further details about protection fuse F see chapter [Installation](#)

### Notes for diagram:

<b>+</b>	12 – 24VDC
<b>-</b>	GND
<b>AO</b>	Analog Output 0-10VDC
<b>I1</b>	Input for push button/switch/potentiometer or 0-10V
<b>TS</b>	Terminal for digital temperature sensor (only for Flush Dimmer 0-10V device compatible digital temperature sensor, which must be ordered separately).
<b>S</b>	Service button (used to add or remove device from the Z-Wave network).

## 10. Adding the device to a Z-Wave network (Inclusion)

### **AUTOMATICALLY ADDING THE DEVICE TO A Z-WAVE NETWORK (AUTO INCLUSION)**

1. Enable add/remove mode on your Z-Wave gateway (hub)
2. Connect the device to the power supply (with the temperature sensor already connected – sold separately\*).
3. Auto-inclusion will be initiated within 5 seconds of connection to the power supply and the device will automatically enrol in your network

### **MANUALLY ADDING THE DEVICE TO A Z-WAVE NETWORK (MANUAL INCLUSION)**

1. Enable add/remove mode on your Z-Wave gateway (hub)
2. Connect the device to the power supply (with the temperature sensor already connected\*)
3. Toggle the switch connected to the I1 terminal 3 times within 3 seconds. The device has to get On/Off signal 3 times, meaning 3 times push of the button or with the normal button 3 times On/Off.

*OR*

Press and hold the S (Service) button for at least 2 seconds

4. A new multi-channel device will appear on your dashboard
5. Inclusion with the switch connected to I1 terminal is not limited by time

\*If connecting the temperature sensor, switch off the power supply and make sure the device is excluded from your network BEFORE connecting the sensor.

## 11. Removing the device from a Z-Wave network (Exclusion)

### REMOVAL FROM A ZWAVE NETWORK (Z-WAVE EXCLUSION)

1. Connect the device to the power supply
2. Make sure the device is within direct range of your Z-Wave gateway (hub) or use a hand-held Z-Wave remote to perform exclusion
3. Enable add/remove mode on your Z-Wave gateway (hub)
4. Toggle the switch connected to the I1 terminal 3 times within 3 seconds. The device has to get On/Off signal 3 times, meaning 3 times push of the button or with the normal button 3 times On/Off.

### OR

Press and hold the S (Service) button between 2 and 6 seconds

5. Exclusion with the switch connected to I1 terminal is not limited by time
6. The device will be removed from your network but any custom configuration parameters will not be erased

### FACTORY RESET

1. Connect the device to the power supply
2. Within the first minute (60 seconds) the device is connected to the power supply, toggle the switch connected to the I1 terminal 5 times within 3 seconds (5 times change switch state)

### OR

Press and hold the S (Service) button for at least 6 seconds

① By resetting the device, all custom parameters previously set on the device will return to their default values, and the owner ID will be deleted. Use this reset procedure only when the main gateway (hub) is missing or otherwise inoperable.

## 12. Associations

Use associations for direct communication between the Flush Dimmer 0-10V and other devices within your Z-Wave network without the need of your primary gateway (hub).

### Association Groups:

#### Root device:

- Group 1: Lifeline group (reserved for communication with the primary gateway (hub)), 1 node allowed.
- Group 2: Basic on/off (status change report for I1 input), up to 16 nodes.
- Group 3: Start level change/stop (status change report for I1 input), up to 16 nodes. Working only when the Parameter no. 1 is set to mono stable switch type.
- Group 4: Multilevel set (status change report of the Flush Dimmer 0-10V) up to 16 nodes. Working only when the Parameter no. 1 is set to mono stable switch type.
- Group 5: Multilevel sensor report (status change report of the analogue sensor) up to 16 nodes.
- Group 6: Multilevel sensor report (status change report of the temperature sensor) up to 16 nodes.

#### End point 1 (Wall Switch I1):

- Group 1: Lifeline group, 0 nodes allowed.
- Group 2: Basic on/off (status change report for I1 input), up to 16 nodes.
- Group 3: Start level change/stop level change (status change report for I1 input), up to 16 nodes.
- Group 4: Multilevel set (status change report of the Flush Dimmer 0-10V) up to 16 nodes.

#### End point 2 (Wall Switch I2):

- Group 1: Lifeline group, 0 nodes allowed.
- Group 2: Multilevel sensor report (status change report of the analogue sensor) up to 16 nodes.

#### End point 3 (External Temperature Sensor):

- Group 1: Lifeline group, 0 nodes allowed.
- Group 2: Multilevel sensor report (status change report of the temperature sensor) up to 16 nodes.

## 13. Configuration Parameters

### Parameter no. 1 – In-wall Switch Type for Load 1 (AO)

With this parameter, you can select between the various input I1 types.

Values (size is 1 byte dec):

- default value 1
- 0 - push-button (momentary)
- 1 - on/off toggle switch
- 2 - potentiometer (the set value will be obtained from the potentiometer or from the gateway (hub)).
- 3 – 0-10V temperature sensor (regulated output)
- 4 – 0-10V illumination sensor (regulated output)
- 5 – 0-10V general purpose sensor (regulated output)



NOTE: After the value of the parameter is changed to the values 3, 4 or 5, first exclude the device (without setting parameters to their default values), wait at least 30s and then reinclude the device!

**Parameter no. 10 - Activate / deactivate ALL ON / ALL OFF Functionality**

Flush Dimmer 0-10V device responds to commands ALL ON / ALL OFF that may be sent by the primary or secondary gateway (hub) within the Z-Wave network.

Values (size is 2 byte dec):

- default value 255
- 255 - ALL ON active, ALL OFF active
- 0 - ALL ON not active, ALL OFF not active
- 1 - ALL ON not active, ALL OFF active
- 2 - ALL ON active, ALL OFF not active

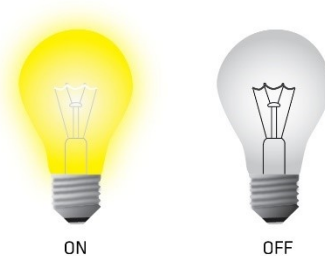
**Parameter no. 11 - Turn Load 1 (AO) Off Automatically with Timer**

If Load 1 (AO) is ON, you can schedule it to turn OFF automatically after a period of time defined in this parameter. The timer is reset to zero each time the device receives an ON command, either remotely (from the gateway (hub) or associated device) or locally from the switch.

Values (size is 2 byte dec):

- default value 0
- 0 - Auto OFF Disabled
- 1 - 32535 = 1 - 32535 seconds (or milliseconds – see Parameter no. 15) Auto OFF timer enabled for a given amount of seconds (or milliseconds)

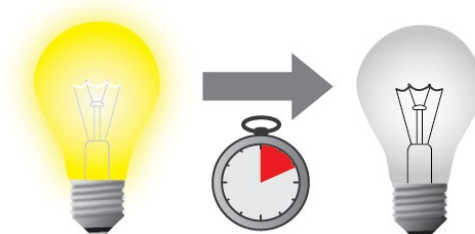

**Parameter no. 12 - Turn Load 1 (AO) On Automatically with Timer**

If Load (AO) is OFF, you can schedule it to turn ON automatically after a period of time defined in this parameter. The timer is reset to zero each time the device receives an OFF command, either remotely (from the gateway (hub) or associated device) or locally from the switch.

Values (size is 2 byte dec):

- default value 0
- 0 - Auto ON Disabled  
1 - 32535 = 1 - 32535 seconds (or milliseconds – see Parameter no. 15) Auto ON timer enabled- for a given amount of seconds (or milliseconds).

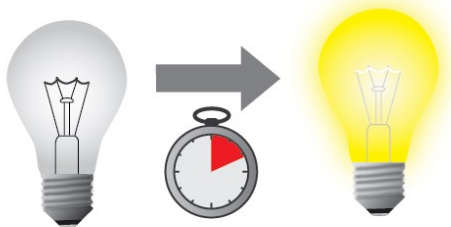
**Parameter no. 21 - Enable/Disable the Double click function**

If the Double click function is enabled, a fast double click on the push-button will set the dimming level to the maximum dimming value.

NOTE: Valid only if input is set as mono-stable (push Button)

Values (size is 1 byte dec):

- default value 0
- 0 - double click disabled
- 1 - double click enabled



**Parameter no. 30 - Restore on/off status for AO load after power failure**

This parameter determines if on/off status is saved and restored for the load AO after power failure.

Values (size is 1 byte dec):

- default value 0
- 0 - Device saves last on/off status and restores it after a power failure.
- 1 - Device does not save on/off status and does not restore it after a power failure, it remains off.

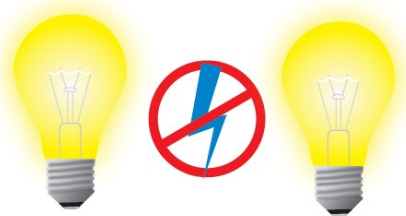
**Parameter no. 52 – Auto or manual selection**

This parameter determines how the configured input (set in the parameter no. 1) influences the output. If, for example, parameter no. 1 is set to the value 2 (configured input is a potentiometer), this parameter should be set to the value 0 (indicating that the input will be controlled manually). If, however, the parameter no. 1 is set to the values 3, 4 or 5 (the output of the device will be automatically controlled by the reading obtained from the sensor), this parameter should be set to the value 1 – Auto.

Values (size is 1 byte dec):

- default value 0
- 0 – Manual
- 1 - Auto

In manual mode, regulation (how the input influences on the output) is disabled.

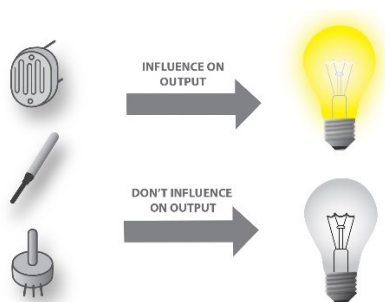



**Parameter no. 53 - PID value inside deadband**

Values (size is 1 byte dec):

- default value 0 (PID value equals ZERO)
- 1 - PID value set to LAST VALUE

NOTE: When ZERO PID inside deadband is forced to zero. LASTVALUE means that PID remains on the same level as was before entering into deadband

**Parameter no. 54 - PID deadband**

Values (size is 1 byte dec):

- default value 1 (1%)
- 0 - 100 = 0 - 100%, step is 1%

NOTE: This parameter defines the zone where PID is not active. If the temperature difference between actual and setpoint is bigger than PID deadband, then the PID will start to regulate the system, otherwise the PID is zero or fixed.

**Parameter no. 55 - Integral sampling time**

Values (size is 1 byte dec):

- default value 5 (5s)
- 0 - 127 = 0s to 127s, step is 1s

Parameter defines the time between samples. On each sample the gateway (hub) capture difference between SP-act.

**Parameter no. 56 - P parameter**

The error is multiplied by a negative (for reverse action) proportional constant P, and added to the current output. P represents the band over which a gateway (hub)'s output is proportional to the error of the system. E.g. for a heater, a gateway (hub) with a proportional band of 10 deg C and a setpoint of 100 deg C would have an output of 100% up to 90 deg C, 50% at 95 Deg C and 10% at 99 deg C. If the temperature overshoots the setpoint value, the heating power would be cut back further. Proportional only control can provide a stable process temperature but there will always be an error between the required setpoint and the actual process temperature.

Values (size is 2 byte dec):

- default value 100
- 0 -1000 - P value, step is 1

**Parameter no. 57 - I parameter**

The error is integrated (averaged) over a period of time, and then multiplied by a constant I, and added to the current control output. I represents the steady state error of the system and will remove setpoint / measured value errors. For many applications Proportional + Integral control will be satisfactory with good stability and at the desired setpoint.

Values (size is 2 byte dec):

- default value 1
- 0 - 1000 - I value, step is 1

**Parameter no. 58 - D parameter**

The rate of change of the error is calculated with respect to time, multiplied by another constant D, and added to the output. The derivative term is used to determine a gateway (hub)'s response to a change or disturbance of the process temperature (e.g. opening an oven door). The larger the derivative term, the more rapidly the gateway (hub) will respond to changes in the process value.

Values (size is 2 byte dec):

- default value 1
- 0 - 1000 - D value, step is 1

### Parameter no. 60 – Minimum dimming value

The value set in this parameter determines the minimum dimming value (the lowest value which can be set on the device, when, for example, a Basic Set Off command is sent to the device).

Values (size is 1 byte dec):

- default value 1 = 1% (minimum dimming value)
- 1- 98 = 1% - 98%, step is 1%. Minimum dimming value is set by entering a value.

NOTE: The minimum level may not be higher than the maximum level! 1% min. dimming value is defined by the Z-Wave multilevel device class.



### Parameter no. 61 – Maximum dimming value

The value set in this parameter determines the maximum dimming value (the highest value which can be set on the device, when, for example, a Basic Set On command is sent to the device).

Values (size is 1 byte dec):

- default value 99 = 99% (Maximum dimming value)
- 2- 99 = 2% - 99%, step is 1%. Maximum dimming value is set by entering a value.

NOTE: The maximum level may not be lower than the minimum level! 99% max. dimming value is defined by the Z-Wave multilevel device class. When the switch selected as Toggle switch (Bi-stable), it is not possible to dim the value between min and max.



**Parameter no. 65 – Dimming time (soft on/off)**

Choose the time during which the device will move between the min. and max. dimming values by a short press of the push-button I1 or through the UI controls (BasicSet).

Values (size is 2 byte dec):

- default value 100 = 1s
- 50 - 255 = 500 milliseconds- 2550 milliseconds (2.55s), step is 10 milliseconds

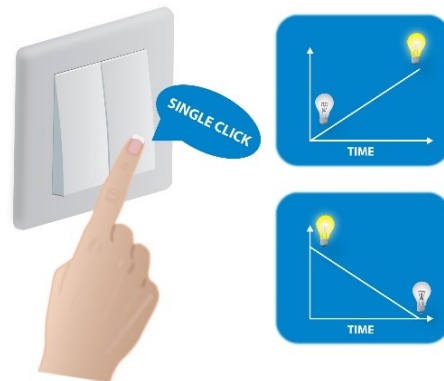
**Parameter no. 66 – Dimming time when key pressed**

Choose the time during which the Dimmer will move between the min. and max. dimming values during a continuous press of the push-button I1 or by an associated device.

Values (size is 2 byte dec):

- default value 3 = 3s
- 1 - 255 = 1 second – 255 seconds

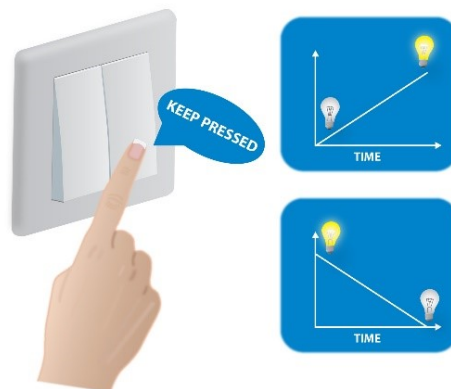

### Parameter no. 67 – Ignore start level

Choose whether the device should use (or disregard) the start dimming level value. If the device is configured to use the start level, it should start the dimming process from the currently set dimming level. This parameter is used with association group 3.

Values (size is 1 byte dec):

- default value 0
- 0 – use the start level value
- 1 - ignore the start level value



### Parameter no. 68 – Dimming duration

Choose the time during which the device will transition from the current value to the new target value. This parameter applies to the association group 3.

Values (size is 1 byte dec):

- default value 0 (dimming duration according to parameter 66)
- 1 - 127 (from 1 to 127 seconds)

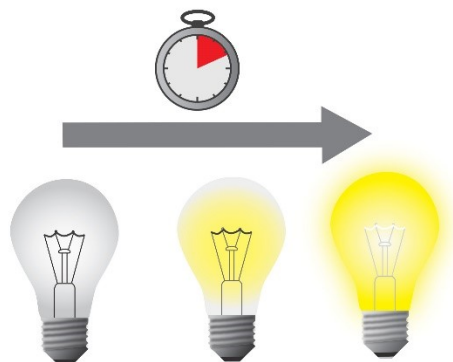

### Parameter no. 110 – Temperature Sensor Offset Settings

Set value is added to or subtracted from the actual measured value to adjust the temperature report sent by an external sensor (sold separately). This parameter only applies to Celsius temperature unit (the Fahrenheit unit is currently not supported).

Values (size is 2 byte dec):

- default value 32536
- 32536 - Offset is 0 °C.
- 1 - 100 - Where 1 stands for 0.1°C and 100 stands for 10.0°C added to the actual measurement.
- 1001 - 1100 – Where 1001 stands for -0.1°C and 1100 stands for -10.0°C subtracted from the actual measurement.

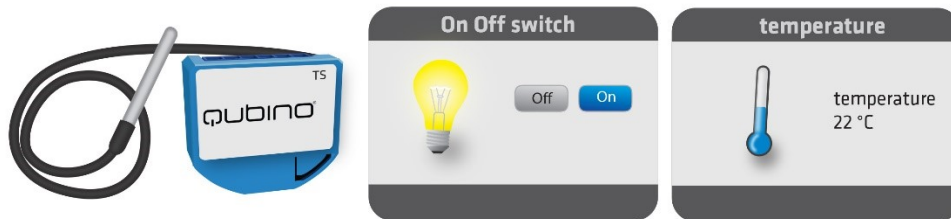

### Parameter no. 120 – Temperature Sensor Reporting Threshold

If an external digital temperature sensor (sold separately) is connected to the device, it reports temperature readings based on the threshold defined in this parameter. This parameter only applies to the Celsius temperature unit (the Fahrenheit unit is currently not supported).

Values (size is 1 byte dec):

- Default value 5 = 0.5°C
- 0 – Reporting disabled
- 1 - 127 = Where 1 stands for 0.1°C and 127 stands for 12.7°C



### Parameter no. 140 – Input I1 Sensor reporting

If an analogue sensor (sold separately) is connected to the device, it reports measured readings based on the threshold defined in this parameter.

Values (size is 2 byte dec):

- default value 5 = 0.5 change
- 0 - Reporting disabled
- 1 - 10000 = 0.1 - 1000 step is 0.1

NOTE: This value has influence on the output only when the parameter no. 1 is set to the values 3, 4 or 5.



### Parameter no. 141 Input I1 0-10V reporting threshold

Define a threshold value for the input I1, which determines whether a BasicSet(0xFF) or BasicSet(0x00) command is to be sent to the associated devices (this parameter is associated with the association group no. 2). Below this threshold value, the association group no. 2 will send a BasicSet(0xFF) command (to the associated devices) and above this value the device will send a BasicSet(0x00) command. The BasicSet commands are reported only when the input value changes for more than 10% (1V).

Values (size is 1 byte dec):

- Default setting: 5 (0.5V)
- 1 - 100 - (0.1 - 10V)



**Parameter no. 143 – Minimum sensor range value**

This parameter (which is taken into account only when the parameter no. 1 is set to the values 3, 4 or 5) specifies the minimum value (lower range value) of the connected sensor.

Available configuration parameters (size is 2 byte dec):

- default value 0 = 0.0°C / 0Lux / 0.0%rh
- 0 - 10000 – value from 0 to 1000 (resolution 0.1)
- 10001 – 20000 – value from -0.1 to -1000 (resolution 0.1)

NOTE: The minimum value must not be higher than the maximum value!

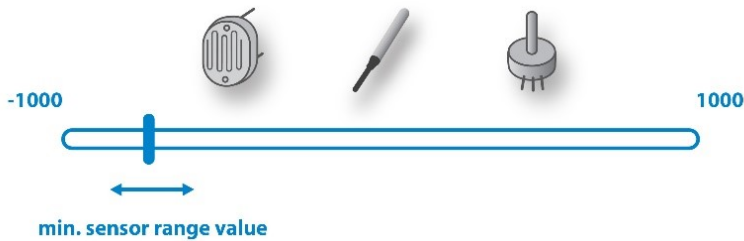

**Parameter no. 144 – Maximum sensor range value**

This parameter (which is taken into account only when the parameter no. 1 is set to the values 3, 4 or 5) specifies the maximum value (upper range value) of the connected sensor.

Available configuration parameters (size is 2 byte dec):

- default value 1000 = 100.0°C / 100Lux / 100%rh
- 0 - 10000 – value from 0 to 1000 (resolution 0.1)
- 10001 – 20000 – value from -0.1 to -1000 (resolution 0.1)

NOTE: The maximum value must not be lower than the minimum value!

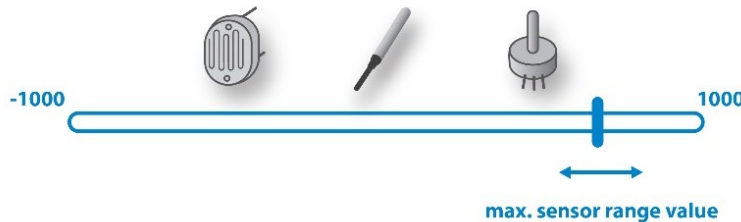



## 14. Technical Specifications

Power supply	12-24VDC*
Max. sinking control voltage	-20 / +20VDC
Max. sourcing control voltage	0-11VDC
Accuracy	<3% FS
Max. sinking current	2mA
Max. sourcing current	7mA
Digital temperature sensor range	-25 ~ +80°C (-13~ 176°F), resolution 0.1°C
Operation temperature	-10 ~ +40°C (14 ~ 104°F)
Z-Wave operation range	up to 30 m indoors (98 ft)
Dimensions (WxHxD) (package)	41,8x36,8x16,9 mm (79x52x22 mm) / 1,65x1,45x0,66 in (3,11x2,05x0,87 in)
Weight (with package)	28g (34g) / 0.98oz (1.20oz)
Electricity consumption	0,5W
Z-Wave Repeater	Yes

\* SELV Type

## 15. Z-Wave Command Classes

### Z-Wave Device Class:

ZWAVEPLUS\_INFO\_REPORT\_ROLE\_TYPE\_SLAVE\_ALWAYS\_ON  
GENERIC\_TYPE\_SWITCH\_MULTILEVEL  
SPECIFIC\_TYPE\_NOT\_USED

### Z-Wave Supported Command Classes:

COMMAND\_CLASS\_ZWAVEPLUS\_INFO  
COMMAND\_CLASS\_VERSION  
COMMAND\_CLASS\_MANUFACTURER\_SPECIFIC  
COMMAND\_CLASS\_DEVICE\_RESET\_LOCALLY  
COMMAND\_CLASS\_POWERLEVEL  
COMMAND\_CLASS\_SWITCH\_ALL  
COMMAND\_CLASS\_SWITCH\_BINARY  
COMMAND\_CLASS\_SWITCH\_MULTILEVEL  
COMMAND\_CLASS\_SENSOR\_MULTILEVEL  
COMMAND\_CLASS\_MULTI\_CHANNEL  
COMMAND\_CLASS\_ASSOCIATION  
COMMAND\_CLASS\_MULTI\_CHANNEL\_ASSOCIATION  
COMMAND\_CLASS\_ASSOCIATION\_GRP\_INFO  
COMMAND\_CLASS\_CONFIGURATION  
COMMAND\_CLASS\_MARK  
COMMAND\_CLASS\_BASIC  
COMMAND\_CLASS\_SWITCH\_MULTILEVEL

### Endpoint 1

#### Device Class:

ZWAVEPLUS\_INFO\_REPORT\_ROLE\_TYPE\_SLAVE\_ALWAYS\_ON

GENERIC\_TYPE\_SWITCH\_MULTILEVEL

SPECIFIC\_TYPE\_NOT\_USED

**Command Classes:**

COMMAND\_CLASS\_ZWAVEPLUS\_INFO

COMMAND\_CLASS\_VERSION

COMMAND\_CLASS\_SWITCH\_ALL

COMMAND\_CLASS\_SWITCH\_BINARY

COMMAND\_CLASS\_SWITCH\_MULTILEVEL

COMMAND\_CLASS\_ASSOCIATION

COMMAND\_CLASS\_MULTI\_CHANNEL\_ASSOCIATION

COMMAND\_CLASS\_ASSOCIATION\_GRP\_INFO

COMMAND\_CLASS\_MARK

COMMAND\_CLASS\_BASIC

COMMAND\_CLASS\_SWITCH\_MULTILEVEL

**Endpoint 2:**

**Device Class:**

ZWAVEPLUS\_INFO\_REPORT\_ROLE\_TYPE\_SLAVE\_ALWAYS\_ON

GENERIC\_TYPE\_SENSOR\_MULTILEVEL

SPECIFIC\_TYPE\_ROUTING\_SENSOR\_MULTILEVEL

Command Classes:

COMMAND\_CLASS\_ZWAVEPLUS\_INFO

COMMAND\_CLASS\_VERSION

COMMAND\_CLASS\_ASSOCIATION

COMMAND\_CLASS\_MULTI\_CHANNEL\_ASSOCIATION

COMMAND\_CLASS\_ASSOCIATION\_GRP\_INFO

COMMAND\_CLASS\_SENSOR\_MULTILEVEL

**Endpoint 3:**

**Device Class:**

ZWAVEPLUS\_INFO\_REPORT\_ROLE\_TYPE\_SLAVE\_ALWAYS\_ON

GENERIC\_TYPE\_SENSOR\_MULTILEVEL

SPECIFIC\_TYPE\_ROUTING\_SENSOR\_MULTILEVEL

**Command Classes:**

COMMAND\_CLASS\_ZWAVEPLUS\_INFO

COMMAND\_CLASS\_VERSION

COMMAND\_CLASS\_ASSOCIATION

COMMAND\_CLASS\_MULTI\_CHANNEL\_ASSOCIATION

COMMAND\_CLASS\_ASSOCIATION\_GRP\_INFO

COMMAND\_CLASS\_SENSOR\_MULTILEVEL

NOTE: The above list is valid for the product with a temperature sensor connected to TS terminal. In case the sensor is not connected then following command class isn't supported:

COMMAND\_CLASS\_SENSOR\_MULTILEVEL\_V7

This product can be included and operated in any Z-Wave network with other Z-Wave certified devices from any other manufacturers. All constantly powered nodes in the same network will act as repeaters regardless of the vendor in order to increase reliability of the network.

**COMMAND\_CLASS\_BASIC:**

The module will be turned ON or OFF after receiving the BASIC\_SET command. To be turned ON: [Command Class Basic , Basic Set, Basic Value = 0x01~0x63 in percentage; FF set to last value]

To be turned OFF:[Command Class Basic , Basic Set, Basic Value = 0x00]

This Security Enabled Z-Wave Plus product can be included and operated in any Z-Wave network with other Z-Wave certified devices from any other manufacturers. All constantly powered nodes in the same network will act as repeaters regardless of the vendor in order to increase reliability of the network.

## 16. Important Disclaimer

Z-Wave wireless communication is not always 100% reliable. This device should not be used in situations in which life and/or valuables are solely dependent on its functioning. If the device is not recognized by your gateway (hub) or shows up incorrectly, you may need to change the device type manually and make sure your gateway (hub) supports multi-channel devices. Contact us for help before returning the device: <https://qubino.com/support/#email>

## 17. Warning

Do not dispose of electrical appliances as unsorted municipal waste, use separate collection facilities. Contact your local government for information regarding the collection systems available. If electrical appliances are disposed of in landfills or dumps, hazardous substances can leak into the groundwater and get into the food chain, damaging your health and well-being. When replacing old appliances with new ones, the retailer is legally obligated to take back your old appliance for disposal free of charge.

## 18. Regulations

### FCC COMPLIANCE STATEMENT:

This device complies with part 15 of the FCC Rules. Operation is subject to the following two conditions: (1) This device may not cause harmful interference, and (2) this device must accept any interference received, including interference that may cause undesired operation NOTE: This equipment has been tested and found to comply with the limits for a Class B digital device, pursuant to part 15 of the FCC Rules. These limits are designed to provide reasonable protection against harmful interference in a residential installation. This equipment generates, uses and can radiate radio frequency energy and, if not in-stalled and used in accordance with the instructions, may cause harmful interference to radio communications. However, there is no guarantee that interference will not occur in a particular installation. If this equipment does cause harmful interference to radio or television reception, which can be determined by turning the equipment off and on, the user is encouraged to try to correct the interference by one or more of the following measures: —Reorient or relocate the receiving antenna. —Increase the separation between the equipment and receiver. —Connect the equipment into an outlet on a circuit different from that to which the receiver is connected. —Consult the dealer or an experienced radio/ TV technician for help.

## Legal Notice

This user manual is subject to change and improvement without notice. GOAP d.o.o. Nova Gorica reserves all rights to revise and update all documentation without any obligation to notify any individual or entity.

## Declaration of Conformity

Qubino Flush Dimmer 0-10V device is in compliance with the essential requirements and other relevant provisions of the Low voltage (LVD) Directive (2014/35/EU), Electromagnetic Compatibility (EMC) Directive (2014/30/EU), Radio Equipment Directive (2014/53/EU), Directive RoHS 2 (2011/65/EU) and Directive ErP (2009/125/EC).

## WEEE

According to the WEEE (Waste electrical and electronic equipment) Directive, do not dispose of this product as household waste or commercial waste. Waste electrical and electronic equipment should be appropriately collected and recycled as required by practices established for your country. For information on recycling of this product, please contact your local authorities, your household waste disposal service or the shop where you purchased the product.



**NOTE: User manual is valid for device with SW version S5 (SW version is part of P/N)!**

**Example: P/N: ZMNHVDxHxS2Px**

**Goap d.o.o. Nova Gorica**

Ulica Klementa Juga 007, 5250 Solkan, Slovenia

E-mail: [info@qubino.com](mailto:info@qubino.com)

Tel: +386 5 335 95 00

Web: [www.qubino.com](http://www.qubino.com)

Date: 17.07.2019; V 2.5

---

[DON'T MISS OTHER INVENTIONS FROM QUBINO– CLICK HERE AND CHECK OUT QUBINO'S COMPLETE PORTFOLIO](#)