

INSTALLATION AND

OPERATION INSTRUCTIONS

V510 Smartphone Video Doorbell

4-Wire IP AHD Video Door Phone

10" Display Series

User Manual

Return to Stock

Product returns require a Return Merchandise Authorization Number(RMA). Please call customer service at 877-435-0670 to receive your RMA number, BEFORE returning any merchandise. Any product returned without an RMA number is subject of being refused and returned to customer. Once received Intrasonic Technology will evaluate the returned items for damaged and completeness. A credit memo will be issued to the customer once the product has been evaluated. Any damaged or missing items will be deducted from the amount credited. Return to stock items must be in unopened original boxes and in like new condition. Credit will not be issued for used or previously installed product. All returns are subject to a 10% restocking charge.

Intrasonic Technology 2 Year Limited Warranty

Intrasonic Technology warrants its products to be free of manufacture defects for 2 years of closing or actual installation. This warranty only applies to products purchased from authorized dealers or distributors. If proof of installation cannot be supplied the manufactures serial number or date code will be substituted. This warranty extends to the original user or subsequent owner of the product during the warranty term. Intrasonic Technology will replace or repair the product at its discretion at no charge with a reconditioned or new product. All products with manufactured defects must be returned to Intrasonic Technology, Inc.

If an Intrasonic Technology product is determined to have a manufactures defect, please call our toll free number (877-435-0670) before any attempt to dismantle the product. Any attempts to dismantle the product will void the warranty.

An RMA (Returned Material Authorization) will be required prior to returning a product to Intrasonic Technology, Inc. To obtain an RMA call our toll free number (877-435-0670) and speak with a customer service representative. All products returned to Intrasonic Technology without an RMA will be refused.

Intrasonic Technology will not be liable for consequential, incidental or damages arising in connection with use or inability to use this product. In no event shall Intrasonic Technology liability hereunder exceed the cost of the product covered hereby. No person is authorized to assume for us or obligate us for any other liability in connection with the sale of this product. Some states do not allow the exclusion or limitation of consequential, incidental or damages, so the above limitation or exclusion may not apply. This limited warranty gives you specific legal rights, and you may also have other rights, which may vary state to state.

Speakers

Intrasonic Technology 10 Year Limited Warranty for Ceiling and In-Wall Speakers

2 Year Warranty for Subwoofer and Accessories

Intrasonic Technology, Including JA Audio In-Wall and Ceiling Speakers warrants for 10 years of closing or actual installation. This warranty only applies to products purchased from authorized dealers or distributors. If proof of installation cannot be supplied the manufacture serial number or date code will be substituted. This warranty extends to the original user or subsequent owner of the product during the warranty term. Intrasonic Technology will replace or repair the product at its discretion at no charge with a reconditioned or new product. All products with manufactured defects must be returned to Intrasonic Technology, Inc.

Video Intercom

Warrants its products for two years of closing or actual installation. This warranty only applies to products purchased from authorized dealers or distributors. If proof of installation cannot be supplied the manufacture serial number or date code will be substituted. This warranty extends to the original user or subsequent owner of the product during the warranty term. Intrasonic Technology will replace or repair the product at its discretion at no charge with a reconditioned or new product. All products with manufactured defects must be returned to Intrasonic Technology, Inc.

Wireless Speaker Kit

Warrants its products for two years of closing or actual installation. This warranty only applies to products purchased from authorized dealers or distributors. If proof of installation cannot be supplied the manufacture serial number or date code will be substituted. This warranty extends to the original user or subsequent owner of the product during the warranty term. Intrasonic Technology will replace or repair the product at its discretion at no charge with a reconditioned or new product. All products with manufactured defects must be returned to Intrasonic Technology, Inc.

Table of Contents

LIMITATION OF LIABILITY.....	1
DISCLAIMER OF WARRANTY.....	1
SAFETY INSTRUCTIONS.....	1
CARING FOR THE ENVIRONMENT BY RECYCLING.....	2
COPYRIGHT STATEMENT.....	2
Table of Contents	3
1. Description Of The Indoor Unit.....	5
1.1 Fitting for the indoor monitor.....	5
1.2 Specifications of the indoor monitor	5
1.3 Note on wiring connection.....	6
1.4 Installation process of indoor units	7
1.5 Wiring diagram.....	8
1.6 Description on the indoor monitor.....	9
1.7 Operation Introduction	10
2. System Settings For Indoor Units.....	13
2.1 Mouse Control.....	13
2.2 Tool Bar	14
2.3 Tool Bar Menu Options	14
2.3.1 Setup	14
2.3.2 Manual Recording	14
2.3.3 Video Playback	14
2.3.4 Photo.....	15
2.3.5 Volume Setting	15
2.3.6 E-Zoom mode.....	15
2.3.7 Channel Status display	16
2.4 Menu Options	16
2.4.1 System	16
2.4.1.1 System-Basic	16
2.4.1.2 System-Time	17
2.4.1.3 System-Video.....	17
2.4.2 Door	18
2.4.2.1 Door Setting - Basic	19
2.4.2.2 Door Setting - Ring	19
2.4.3 Network	20
2.4.3.1 Network-Basic	20
2.4.3.2 Network-Port	20
2.4.3.3 Network-Advanced	21
2.4.4 Record Scheduling	23
2.4.5 Alarm	24
2.4.6 Maintenance	25
2.4.6.1 SD	25

2.4.6.2 Upgrade	26
2.4.7 User	26
2.4.8 Default	29
2.4.9 Information	29
2.4.10 Save/Exit.....	29
3. Web Browser Operation.....	30
3.1 Feature.....	30
3.2 Network Security Setting.....	30
3.3 Connection Settings	31
3.4 Control Download and Installation	32
3.5 Operation Interface	33
3.5.1 Live.....	33
3.5.2 Controls	34
3.5.3 Other Operations.....	34
3.5.4 Playback	34
3.5.5 Toolbar Guide.....	36
3.5.6 Remote Settings.....	36
3.5.7 Local Settings	39
3.5.8 Logout	39
4. Mobile Phone Software Visit	39
4.1 Iphone Mobile or Ipad	39
Appendix 1. Accessing the indoor unit via Mozilla Firefox	41
Appendix 2. Accessing the indoor unit via Google Chrome.....	41
Appendix 3. Remote Control(Optional)	42
Appendix 4 How to ensure reliable remote viewing of the indoor device through IE browser on Win7/Win8 64bit OS..	43

1. Description Of The Indoor Monitor

1.1 Fitting for the Indoor Monitor

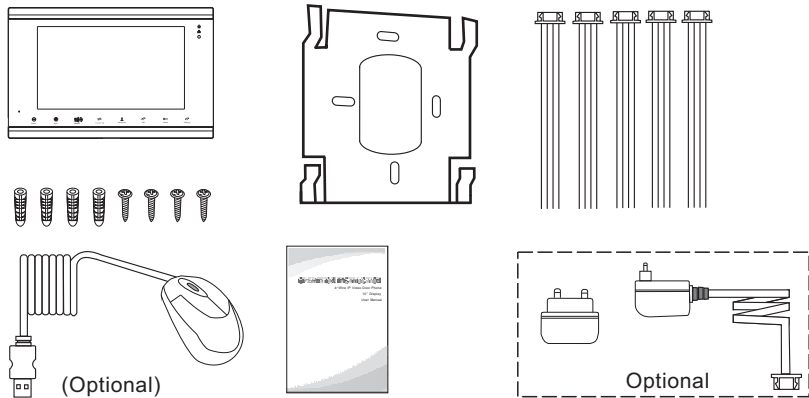

- ◆ Indoor Monitor ----- 1 pcs
- ◆ Screw Anchors ----- 4 pcs
- ◆ Wall Screws ----- 4 pcs
- ◆ Bracket ----- 1 pcs
- ◆ 4 Pin Line ----- 5 pcs
- ◆ This Quick Guide----- 1 pcs
- ◆ External Switching Power Adapter(Optional)----- 1 pcs
- ◆ USB Mouse(Optional)----- 1 pcs

1.2 Specifications of the Indoor Monitor

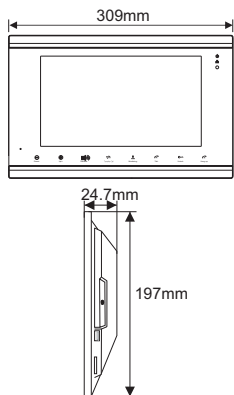

Display	10.1 inch TFT LCD(16:9)
Resolution	1024*600
Video system	PAL/NTSC compatible
Intercom mode	Semi-duplex communication
Conversation duration	120 seconds
Power consumption	12W max.
Power supply	External Switching Power Supply(DC 12V/2A)--Optional Built-in power supply(AC100V~240V)--Optional
Operation temp.	-10 ℃~+60 ℃
Installation	Surface mount
Dimensions	309*197*24.7mm

1.3 Note On Wiring Connection

⚠ The indoor monitor with a separate power supply or an external power supply is optional. please refer to actual control using. If the indoor monitor with a built-in power supply, applicable to wide voltage range(AC 100V~240V). Please first pull out the AC power plug before installation of device(shown as below).



i Please note the silk printing marked on PCB in order to avoid incorrect connecting.

The wiring connection requirement:

1. 4C ordinary non-STP wiring cable;
2. Effective distance from the outdoor camera to furthest indoor monitor:
 - Transmission ≤28m (4x0.2mm²)
 - Transmission ≤50m (4x0.3mm²)
 - Transmission ≤80m (4x0.5mm²)



Non-STP wiring cable

i Wire connection according to the following to avoid interference:



1.4 Installation Process of Indoor Units

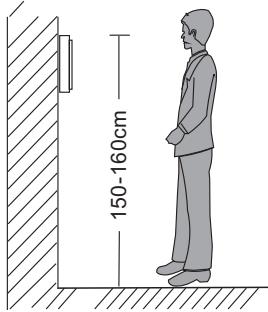

⚠ NOTE:

- * Switch off power supply before installing.
- * Keep more than 30cm away from AC power supply to avoid external interference.

To install the indoor unit , please follow these steps as below:

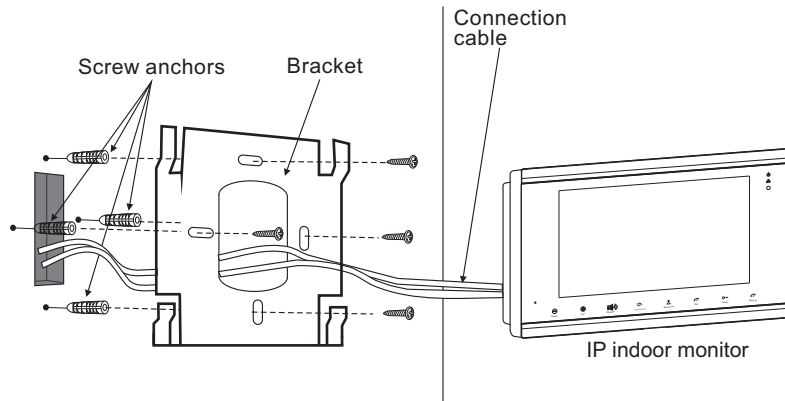

1.5 Wiring Diagram

For IP 10" AHD display series, users can connect up to 2 AHD(720P) outdoor doorbells or 2 IP outdoor cameras, 2 CCTV cameras and three extension CVBS indoor monitors(video door phone) one by one to the corresponding interfaces . The power supply with a built-in power or an external power is optional.

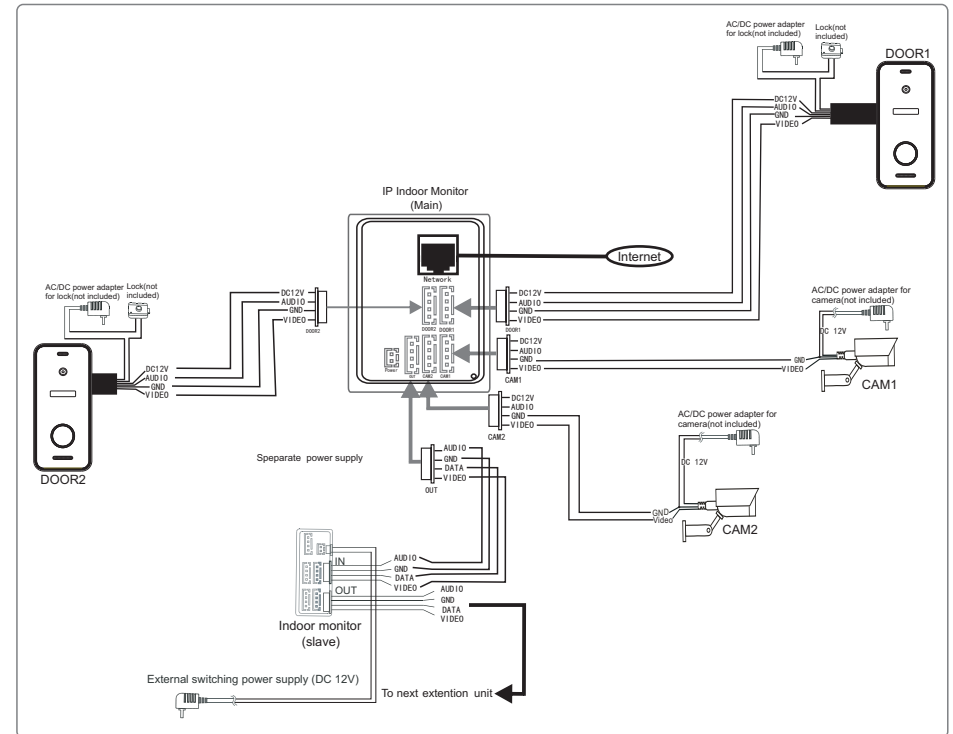

1.6 Description On The Indoor Monitoring

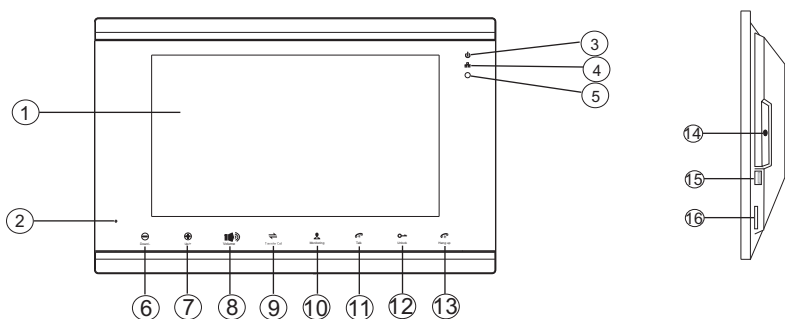

NO	Name	Descriptions
1	TFT display	View visitor's image displayed on the TFT screen
2	Microphone	Transmit the voice to outdoor camera
3		Power LED
4		Network LED
5		1. Decrease volume. 2. On menus press the button to move the cursor downwards.
6		1. Increase volume. 2. On menus press the button to move the cursor upwards.
7		1. Adjust volume. 2. On menus press the button to move the cursor leftwards.
8		1. Transfer call, press the button transfer call to another indoor monitor. 2. On main menu or sub-menu, press the button to move the cursor rightwards.
9		Monitoring, press the button to watch the outdoor doorbell and CCTV camera images.
10		1. Talk, press the button to activate conversation mode. 2. In standby mode, press this button to intercom call to another indoor monitor.
11		1. Unlock, release the door lock. 2. On main menu or sub menus, press the button to confirm.
12		1. Hang up, press this button to end conversation mode. 2. In standby mode, press the button once to access the menu bar. 3. On menus press the button to exit the current menu interface.
13	Speaker	Sound from outdoor camera.
14	USB Port	To connect the USB mouse to the device.
15	SD Port	SD card interface, support up to 128G SD card for recording and captures. If the SD card is less than 64GB, it must be formatted as fat32 before using. If the SD card is more than 64GB, it must be formatted as exFAT before using. And suggest that it's better to use a SD card more than class 10 onto the device.

1.7 Operation Introduction

◆ VISITOR CALL

* Please be aware of Connection of 2 outdoor cameras is required.

Standby mode

The Visitor press the **call** button on outdoor camera 1

10s of continuous ring tone is heard inside and outside

The visitor's image automatically displayed on the screen

Press the **talking** button

Stop ringing

Start conversation with outdoor camera

The conversation duration is 120s at a time

Press the **unlock** button on indoor monitor

release the door lock

The Visitor press the **call** button on outdoor camera 2

Press the **Hang up** button on indoor monitor again

End

NOTICE:

The indoor unit will automatically go into standby mode if you are not at home or have not reached the indoor unit in 60s.

i Both the visitor's voice and image will be not switched off within 20s of time span when the **unlock** button is pressed.

i For the models with SD card, if the SD card has been inserted into the indoor monitor, when some visitor press the call button on outdoor doorbell, the device will start recording with audio.

i If a conversation with an outdoor doorbell is underway in monitoring mode, during this time a visitor press the call button on another outdoor doorbell, a beep from the indoor monitor will be heard.

◆ MONITORING

* Please be aware, Connection of 2 outdoor cameras to 1 indoor monitor is required for dual entrance monitoring at least.

Standby mode

Press the **monitoring** button on indoor monitor



Press the **monitoring** button on indoor monitor again



display image from 1st outdoor camera on the screen.



display image from 2nd outdoor camera on the screen.

▼ monitoring duration is up to 60s at a time



Press the **talking** button

Press this button once more to return to standby mode



Start conversation with outdoor camera



Press the **unlock** button to release the door lock



Press the **Hang up** button again



End



NOTICE:

If you are using only one outdoor camera in **monitoring** mode, you can also end the **monitoring** mode by pressing the **monitoring** button again.

◆ CALL TRANSFER TO OTHER EXTENSION

* At least 2 indoor units is required

Outdoor camera call indoor monitor and conversation is underway



NOTICE:

When you are transferring a call to other extension, the original conversation indoor unit will return to standby mode.

Press this button to access **Call transfer to other extension**

▼ A continuous Ding Dong tone is heard

Press the **talking** button on any of indoor units



Start conversation with outdoor camera



NOTICE:

To release door lock, end conversation; please refer to page 10 as reference.

◆ INTERNAL COMMUNICATION AMONG INDOOR UNITS

* At least 2 indoor units is required

Standby mode



NOTICE:

In **internal communication** mode, if a visitor press the call button on either outdoor unit, the **internal communication** mode will be switched off. The visitor's image will appear on its screen and continuous ringing will be heard. you can press the **talking** button to reactivate conversation with the visitor; for more detailed operations, please refer to **VISITOR CALL** on page 10.

Press the **talking** button

▼ A continuous Ding Dong tone is heard

Press the **talking** button on any of indoor units



Start conversation among indoor units









Press the **hang up** button again



End

2. System Settings For Indoor Units

- Note:**
1. Users can use a mouse or press buttons on the front panel to operate the device.
 2. In standby mode, press the button “” to bring up the menu tool bar, move the cursor to select menu option, press the button “” to move the cursor left, press the button “” to move the cursor right, press the button “” to move the cursor upwards, press the button “” to move the cursor downwards. Press the button “” to confirm after adjusting values or selecting options. On menus, press the button “” to exit current menu interface.
 3. Router b/g/n--The IP indoor monitor with wireless network works on 802.11(b/g/n) network.

2.1 Mouse Control

User can use a mouse to operate the device. The mouse operates just like a mouse on a typical computer. To start, connect the mouse to the USB port on the side panel of the indoor unit; note that you can hot-plug the mouse.

Right-clicking	<ol style="list-style-type: none"> 1. In live view, right-clicking will either display or hide the toolbar. 2. From the main menu or a sub-menu, right-clicking will exit the current menu. 3. In video playback, right-clicking will either hide or display the control bar.
Left-clicking	<ol style="list-style-type: none"> 1. In menu unlock mode, left-clicking on the SETUP icon in the toolbar will open the main menu. 2. After entering the main menu, left-clicking will open sub-menus. 3. By left-clicking, you can select values in edit boxes or pull-down menus. The system supports the input of Chinese characters, and other special symbols, numbers, and letters. 4. Left-clicking can be used to access the color control bar, the volume control bar, and the screen control bar. 5. From the main menu, sub-menus, or playback view, left-clicking “x” will exit the current menu. 6. Left-clicking can also be used to select menu items.
Double-clicking left mouse key	In live view or video playback, double-clicking will maximize the screen.
Mouse Drag	In the motion detection setting interface, you can left-click and then drag the frame to set the motion detection area.

2.2 Tool Bar

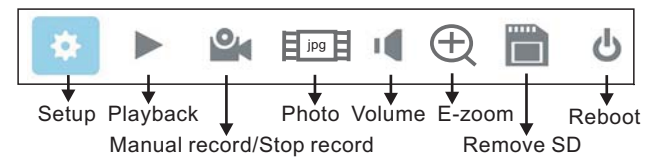

Single-click the right-hand mouse button, and it will display the following toolbar.



2.3 Tool Bar Menu Options

2.3.1 Setup



After clicking this button “”, a screen for configuring all system settings will appear. From this screen, system, video playback, network, scheduling, alarm, maintenance, user and default information can be adjusted.

- Note:**
1. If there is a “” button in the sub-menu, users need to click the “” button to save parameters in the current window.

2.3.2 Manual Recording

There are two ways of recording live video/audio feed from your cameras: manual recording and scheduled recording.

If scheduled recording is in conflict with manual recording, the manual recording will be processed first until stopped.

For a detailed description of scheduled recording, see [Section 2.4.3 Record Scheduling](#). In order to manually record a video/audio feed, click the “” button from the “Tools” menu. Clicking “” again will stop the recording process.

2.3.3 Video Playback





To start video playback, first move the cursor to “” (the icon will be highlighted when selected) and left-click it to enter the settings menu.



Input the date and time, choose ‘Media’ type: including “Video” and “Photo”, click “” and the recording status on that date will be displayed. If choose “Video”, the calendar on the above figure will show all the recordings in a given month. A background on the calendar indicates

indicates that there was recording on the day. Click any date in this frame to search by the recording files of that day, and the search results will be shown in the file frame. On the file list, “**Channel**” shows which channel the file was recorded under, “**Time**” shows the recording time, and “**Size**” is the size of this file (listed in MB). An orange list indicates this recording file is a motion detection recording file green list indicates this file is a normal recording file, and a gray background indicates that there was no recording. By choosing “**Photo**”, all snapshots will be shown on the list.

Left-click the file to enter the playback menu. It will play the video from a single channel in full-screen view. When the selected files finish, the screen will return to the file list menu.

Clicking “” button to enter into the first page, clicking “” button to previous, clicking “” button to the next page, and clicking “” to the last page.

Note:

1. After selecting the files, click it to enter the playback menu. It will play the video from a single channel in full-screen view.

2. When the selected files finish, the screen will return to the file list menu.

Playback Control

A. Playback Video

In video playback mode, users can view the playback control panel as well as the date and time of the file being played.

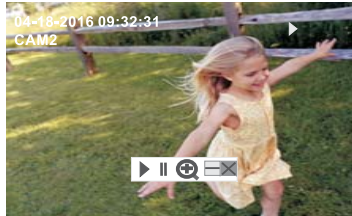

The following are the functions of and options for the items in the playback control panel:

- ▶ Play
- || Pause
- 🔍 E-zoom, the e-zoom function will be disabled with the resolution of CIF recordings.
- ☰ Minimize the control panel.
- ✕ Exit from playback and return to the former menu.

B. Playback Picture



In picture playback mode, the following are the functions of and options for the items in the playback control panel:

- ◀ To switch the current picture to the last one.
- ▶ To switch the current picture to the next one.
- ☰ Minimize the control panel.
- ✕ Exit from playback and return to the former menu.

2.3.4 Photo

In full screen click “” to capture a frame of the video stream as a still photo.

2.3.5 Volume Setting

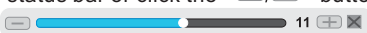
Single-click “” on the tool bar menu to enter the “volume” bar to adjust the volume for the indoor monitor during intercom. When the indoor monitor is conversation with the outdoor bell, drag the volume control status bar or click the “” button to adjust the volume.





2.3.6 E-Zoom Mode

Click “” to enter zoom mode, and then left-click and drag the cursor to select the area to be magnified. Right-click to exit zoom mode.

2.3.7 Channel status display

The following status icons will appear in the lower left corner of each channel frame.

-  This indicates that the channel has detected motion while in motion-detection mode.
-  This indicates that the channel is running in normal recording.

2.4 Menu Options

In order to modify or adjust the system configuration, it is necessary to enter the “Setup” menu; to do this, click the “Setup” icon () in the “Tools” Menu.

After clicking the “Setup” icon, a dialog box with settings for all of the systems and options available for the device will appear. The settings are divided into nine subsections: “System”, “Door”, “Network”, “Scheduling”, “Alarm”, “Maintenance”, “User”, “Default” and “Information”. The following are detailed descriptions of these settings.

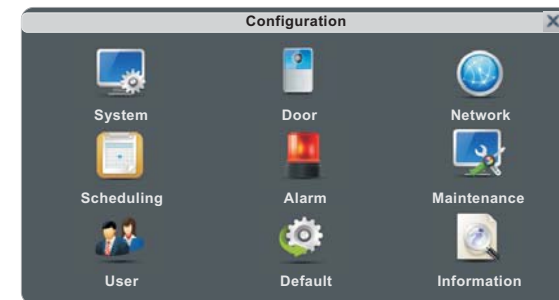

2.4.1 System

Move the cursor to the “System” icon and left-click to enter the “System” menu. System setup includes: “Basic configure”, “Time” and “Video”.

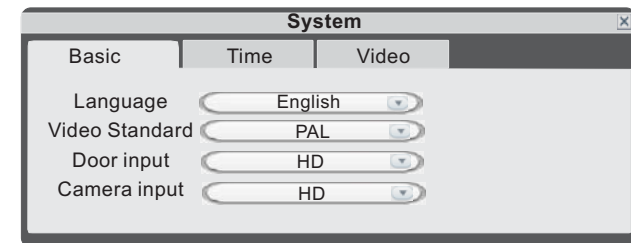

2.4.1.1 System-Basic

Basic configure includes: “Language”, “Video Standard”, “Door input” and “Camera input”.

[Language]: Use this field to change the language of the device menu text and the on-screen display.

[Video Standard]: From this field, select the system output type that is consistent with camera input, i.e. PAL or NTSC.

[Door input]: From this field, select the video input mode that is consistent with doorbells. There are two options: HD and D1 resolutions. When the option is “HD”, user must connect AHD(720P) outdoor doorbells. When the option is “D1”, user can only connect CVBS outdoor doorbells.

[Camera input]: From this field, select the video input mode that is consistent with CCTV cameras. There are two options: HD and D1 resolutions. When the option is “HD”, user must connect AHD(720P) CCTV cameras. When the option is “D1”, user can only connect CVBS CCTV cameras.

2.4.1.2 System-Time

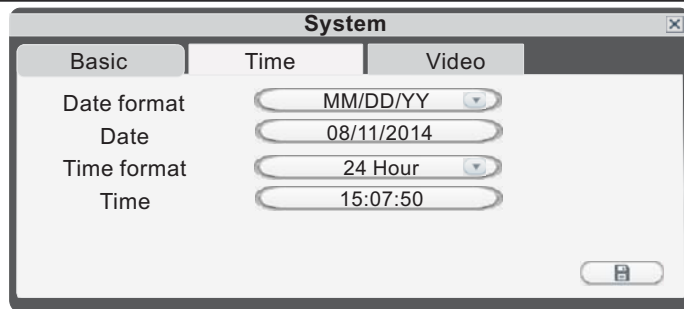

[Date Format]: Left-click to switch the date format, include YY/MM/DD, MM/DD/YY and DD/MM/YY.

[Date]: Left-click to switch the numerical keypad, and set the date using the numerical keypad.

[Time Format]: Left-click to switch the time format from a 12-hour clock to a 24-hour clock and vice versa.

[Time]: Left-click to switch the numerical keypad, and set the system time using the numerical keypad.

2.4.1.3 System-Video

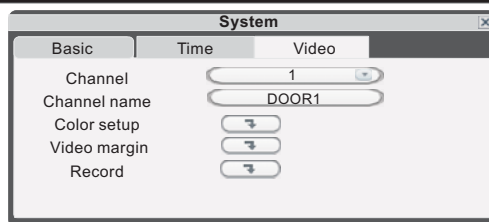

[Channel]: In this field, select a channel to be set up.

[Channel name]: Users can modify the name of each channel. Note that the name of each channel must not exceed eight Roman letters or four Chinese characters.

[Color Setup]

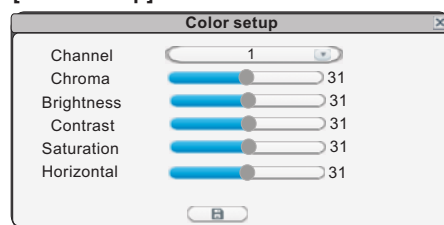

Click “ ” to enter the “Color Setup” menu.

From this menu, the video color attributes can be adjusted for the best image quality. By default, the values are set at 31, as this is the median value. Make adjustments to the chroma, brightness, contrast, and/or saturation as appropriate depending on the actual conditions at the location where the camera is installed. The video image position can be

adjusted horizontally.

Click the vertical bar on the slide bar and drag the cursor to the left or right to set color attributes. Once the color attributes have been set, click “ ” to save the settings.

[Video Margin]

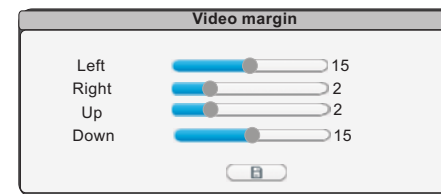

Click “ ” to enter the “Video Margin” menu, the entire video screen can be moved up, down, to the left, and to the right using this option.

[Record]

Click “ ” to enter the “Record” menu to set up “Resolution” and “Frame rate” for every channel.

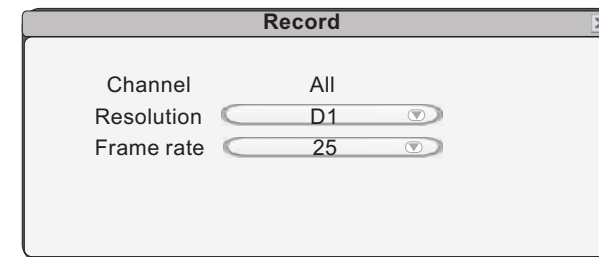

[Resolution]: This indicates the setup resolution and code rate for recording. There are two options: D1 and CIF resolutions. The recording resolution of all channels can only be adjusted synchronously.

[Frame rate]: In this field, users can choose the recording frame rate (frames per second) for every channel. The higher the recording frame rate, the more natural the movement seen in playback mode will seem. Select a recording frame rate depending on the how carefully the activity in the video needs to be monitored. For the PAL video output format, users can set the frame rate at 25 frames per second with each channel; this means the system will record 100 frames per second with all channels running (if there are four channels that are all recording). Users can set the frame rate from 1 to 25 frames per second for each channel. For the NTSC video output format, users can set the frame rate at 30 frames per second for each channel, which means the system will record 120 frames per second with all channels running (if there are four channels that are all recording).

2.4.2 Door

Left-click the “Door” icon to enter the “Door setting” menu. Door setting includes: “Basic”, and “Ring”.

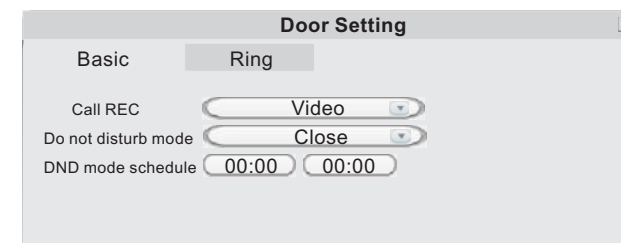

2.4.2.1 Door Setting-Basic

Basic configure includes: “Call REC” and “Do Not Disturb mode”.

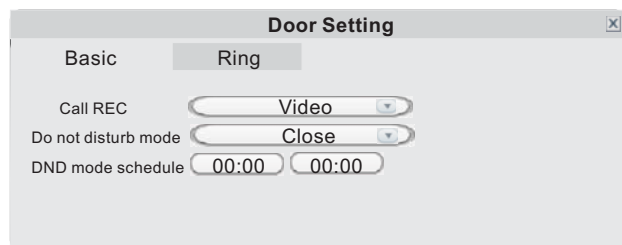

[Call REC]: Use this field to set up record mode when calling on the doorbell. Options include “video” and “photo”. For the video mode, the whole process will be recording from the start of a call. For the photo mode, if a visitor calls on the outdoor doorbell, the first picture will be captured.

[Do not disturb mode]: Enable or disable “Do not disturb mode”.

[DND mode schedule]: To set up the No disturbing time. When No Disturbing mode is enabled, outdoor doorbell calls and alerts will be silenced during the period time of the No Disturbing mode.

2.4.2.2 Door Setting-Ring

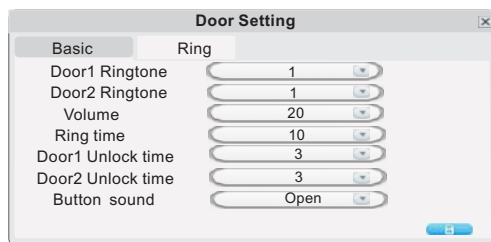

[Door1 Ringtone]: From this field, set up the ring tone of Door 1, a total of 16.

[Door2 Ring]: From this field, set up the ring tone of Door2, a total of 16.

[Volume]: From this field, set up the volume of the ring, values can be set from 0 to 20.

[Ring time]: From this field, set up the ring time of the ring, values can be set from 5 seconds to 30 seconds.

[Door1 Unlock time]: From this field, set up the unlock time of door1, values can be set up from 1 second to 10 seconds.

[Door2 Unlock time]: From this field, set up the unlock time of door2, values can be set up from 1 second to 10 seconds.

[Button sound]: To enable or disable keypad tone when pressing the buttons on the front panel of the indoor device.

2.4.3 Network

Move the cursor to the “Network” icon and left-click to enter the “Network” menu. Network setup includes: “Basic Setup”, “Port” and “Advanced”.

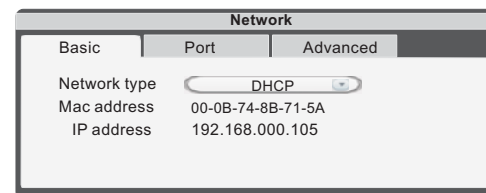

2.4.3.1 Network-Basic

[Network Link]: There are two options: “Static” and “DHCP”.

After selecting an Internet connection setting - such as static or DHCP – and allocating a port, users can access the device remotely via the Internet.

1) If static allocation has been selected, it is necessary to set up an IP address, a subnet mask, a gateway, and a Web port.

[IP Address]: Enter the IP address in this field.

[Subnet Mask]: Input numbers for the subnet mask.

[Gateway]: Enter numbers for the default gateway.

[DNS Address]: Input numbers for the subnet mask in this field.

2) If DHCP is selected, the server will allocate an indoor unit IP address automatically.

NOTE: Save the IP address when selecting DHCP and the indoor monitor will automatically connect with the server. It will allocate an IP address when the connection is stable, and this address will be displayed on the interface.

2.4.3.2 Network-Port

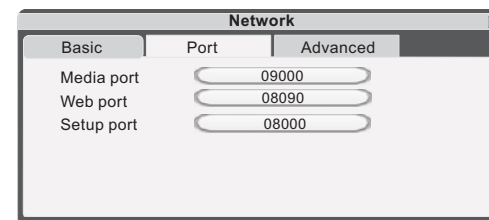

[Media Port]: Port for the private protocol of the device and computer; the default is “9000”. If this port is being used by other server, use another free port for the device.

[Web Port]: Sets up a Web browser port via HTTP. The default port number is “8090”, but the specific number is model-dependent. If Administrator changes the Web port, for example, “8088”, the port number should be added after the IP address, i.e. http://192.168.15.145:8088 should be entered as the IP address of the Web browser.

[Setup Port]: It’s used to control the device. The default number is “8000”. User can specify a different port number.

2.4.3.3 Network - Advanced

In advanced menu, user can set up DDNS, Wifi, UPNP, Mobile phone, Sub Stream and IP firewall.

“” indicates the selected option is enable. Click “▶” to enter into the next page, and click “◀” to the previous.

Note: User should enable the relevant function with “” before setup.



A. DDNS

“” indicates DDNS is enabled. Move the cursor to “DDNS” (the tab will be highlighted when selected) and single-click to enter the DDNS setup menu.

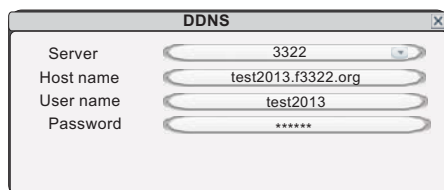

[Server]: There are three options: “3322”, “dyndns” and “easterndns”.

[Host Name]: In this field, enter the name of the host server.

[User Name]: In this field, enter the username.

[Password]: In this field, enter the password.

B. Wifi (Optional)

For the indoor monitor with WIFI function, users can visit the device remotely by the following methods: through network cable connection or through wireless connection. If through wireless connection, please setup the parameters about Wifi manually.

First enable the option “WIFI”, “” indicates Wifi is enabled.

Move the cursor to “Wifi” (the tab will be highlighted when selected) and single-click to enter the Wifi setup menu.



1) Click “” and available wireless devices will be shown on the list. Choose one and click it, if the wireless password of the wireless router is enabled will a window to enter the password of the wireless router. Input the correct password and setting, the indoor device will reboot automatically. It will be connected to the wireless router after starting. Now the wireless function of the indoor device has been activated.

2) Click “” to enter the interface as follows, input the correct information about the wireless router.

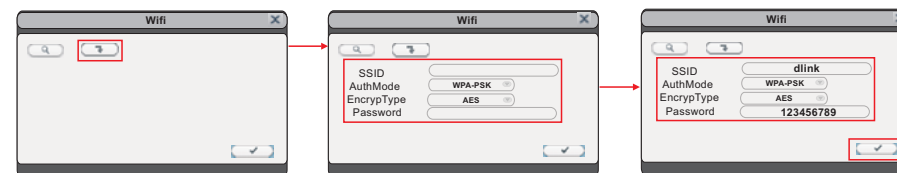

[SSID]: Input the wireless router SSID.

[Password]: If the password of the wireless router is enabled, the option should be set to “”.

[AuthMode]: Options include “WPA-PSK” and “WPA2-PSK”.

[EncrypType]: Options include “AES” and “TKIP”.

[Key]: Input the password of the wireless router.

Click “” to save, restart the indoor device manually and the wireless function of the device will take effect.

C. UPNP

“” indicates UPNP is enabled.

D. Mobile Phone

Move the cursor over “Mobile Phone” (the tab will be highlighted when selected), and single-click to enter the mobile settings menu.

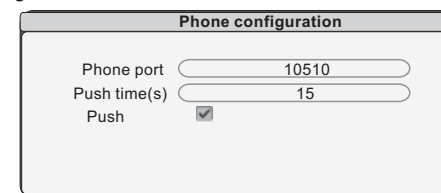

[Phone port]: Mobile monitoring port. In this field, enter the relevant mobile port. The range for server ports is between “1024” and “65535”. The default is “10510”.

[Push time(s)]: From this field, set up delay duration time of alarm push for visitor calling when nobody answers on the indoor unit, and values can be set up from 0 to 30s. For example, to select 15s, if visitor presses the call button on the outdoor camera, the message will be pushed onto the master’s phone after 15 seconds when nobody answers on the indoor monitor.

[Push]: “” indicates the push function is to be enabled.

E. Sub Stream

Move the cursor over “Sub Stream” (the tab will be highlighted when selected), and single-click to enter the Sub steam menu.

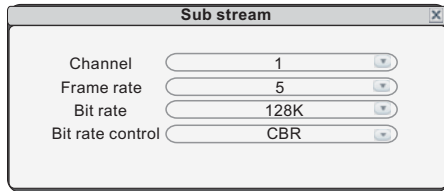

[Channel]: After clicking the “Channel” tab, users can modify the settings of the camera connected to the selected channel. Users can modify the parameters of each channel independently.

[Frame rate]: For the PAL video output format, options include 5-25 frames. For the NTSC video output format, options include 5-30 frames.

[Bit rate]: There are 5 options: 64K, 128K, 192K, 256K and 384K.

[Bit rate control]: There are two modes for bit rate control: VBR and CBR. If users choose CBR mode, the video encoder will encode according to the bit rate you have selected. If users choose VBR mode, the video encoder will consider to the image quality and encode according to the bit rate have been selected, but not strictly according to this bit rate. Suggest VBR mode.

F. IP Firewall

Move the cursor over “IP Firewall” (the icon will be highlighted when selected), and single-click to enter the IP Firewall menu.

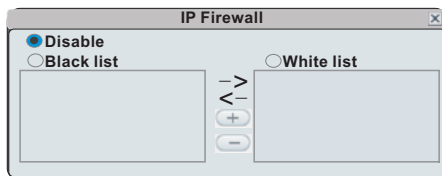

The options for IP access settings are: “disable”, “Black list” and “White list”.

2.4.4 Record Scheduling

Click “Setup”—“Scheduling”(the tab will be highlighted when selected) and single-click to enter the “Record Scheduling” menu.





[Channel]: Users can select channel 3 or channel 4.



There are five modes for recording: “MD”, “Normal”, “None”. Different colors are used to identify the different recording modes: Orange refers to “MD record”, green refers to “normal record”, gray refers to “no record”.



To set up weekly schedules, click on the box of the recording status to be used (Alarm, Normal, or No record) and then click on each box in the schedule timeline that this recording status is to be applied to. See the “Scheduling” screenshot in the preceding figure. Each gray block represents one hour on a 24-hour clock, i.e. the first block(next to each day of the week).

represents the hour from midnight-01:00 AM and the last block (below the “23” on the right hand side of the screen) represents the hour from 11:00 PM-midnight. After setting up the record schedule, click the “” button at the bottom of the screen to save it.

Alternatively, left-click and drag the frames of the boxes in the schedule timeline where you want to.

Another way to set up schedules is to create a schedule for one day of the week, and then use the “Copy from” and “to” dropdown menus and “” copy button settings to apply the setting from one day to another day or a series of up to all seven days of the week. To do this, first create a schedule for one day. Then, from the “Copy from” dropdown menu, select the first day of the week that the schedule should apply to. Next, from the “to” dropdown menu, select the last day of the week that the schedule should apply to, and click “” copy button. For example, to set a schedule where the device uses MD recording from 2:00 AM until 1:00 PM, and normal recording from 1:00 PM until 10:00 PM on Tuesdays, Wednesdays, Thursdays, and Fridays, the process would be as follows:

1. Click the orange box at the bottom of the screen to select “MD record.” Then, in the row of gray boxes next to the “TUE.” box, click all of boxes from the third box from the left to the box under the “12” at the top of the timeline(the box directly under the “12” should be selected) in order to select the hours between 2:00 AM and 1:00 PM.
2. Click the green box at the bottom of the screen to select “normal record.” Then click all of the boxes in the same row from the box immediately to the right of the box under the “12” at the top of the timeline to the third box from the right to select the hours from 1:00 PM-10:00 PM.
3. The preceding steps set a schedule for Tuesday, which can now be copied to Wednesday, Thursday, and Friday. To copy it, from the “FROM” field, first select “Tues.”
4. In the “To” field, select “Fri.” and then click “” copy button.
5. To save this schedule, click the “” button at the bottom of the screen.

Regardless of whether the schedule is set for each day individually or by copying one schedule to multiple days of the week, it is necessary activate it by clicking the “” button. Without clicking the “” the schedule will not take effect.

2.4.5 Alarm

Click “Setup”—“Alarm”(the tab will be highlighted when selected) and single-click to enter the “Alarm” menu to set up motion detection alarm.

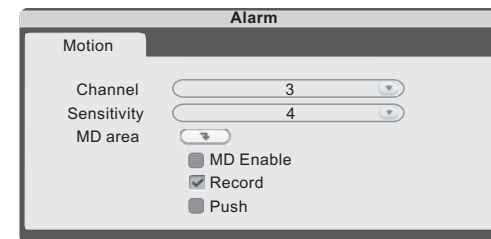

To enter motion setup, the dialog window where Sensitivity, MD Area, Enable Switch, record settings and Push Switch can be set will appear.

[Channel]: In this field, select the channel to be set up.

[Sensitivity]: Each channel has a specific sensitivity setting; there are eight levels, with “1” being the highest level of sensitivity; left-clicking to adjust the level.

[MD Area]: Sometimes, it is necessary to have some regions in the camera's coverage area enabled with the motion detection feature, while other regions in the same coverage area do not require this functionality. This may be handy when, for example, the camera covers the road and an adjoining area.

While it would be useful to have the motion detection enabled on the area near the entrance to a building, it would most likely not be helpful to see it triggered every time a car or truck passes by on the nearby road. Each channel has a specific regional motion detecting setting. Move the cursor to  and then single-click. When viewing the selected channel's coverage area using the MD Area option, the blue area is where motion detection is activated, and transparent block is the area where motion detection is not activated.

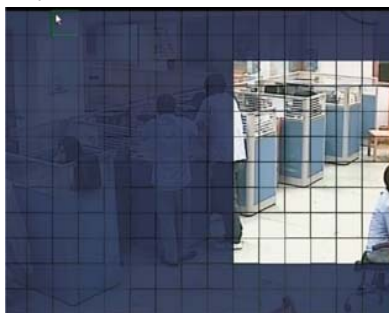

Left-click and drag the frame to set up the region for motion detection.

[MD Enable]: Each channel has a corresponding channel switch. indicates that the motion detection alarm of the selected channel is enabled.

[Record]: indicates that the selected channel will record if it has been triggered by motion.

Note: To select the option, please make sure that a SD card has been already inserted into the video data can be stored onto the SD card normally.

[Push]: indicates that a detection information will be pushed to user's phone if the selected channel has been triggered by motion.

Note: Please make sure that the indoor monitor and user's phone are both connected to internet.

2.4.6 Maintenance

Click "Setup"—"Alarm"(the tab will be highlighted when selected) and single-click to enter the "System Maintenance" menu. Options include "SD Management" and "System Upgrade".

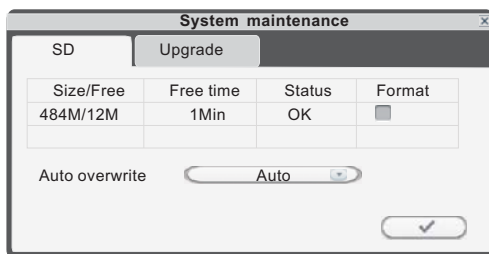

2.4.6.1 SD

To enter the "System Maintenance", select "SD" (see adjacent figure).

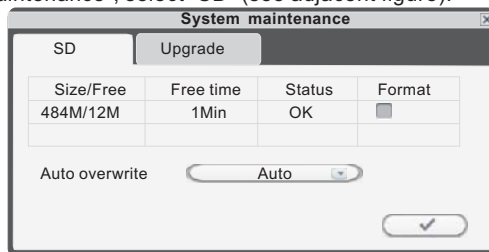

[Size/Free]: This field indicates amount of space available and the amount of unused space available on the SD card. The capacity of the SD can be used up to 128GB.

[Free Time]: Indicates remaining recording time on the SD card.

[State]: There are two available statuses: "OK" and "No SD". If a new SD card is used with the device for the first time, please format the SD card.

[Format]: Move the cursor to select the device to be formatted, indicates the option of "format" is enabled, and click  to begin formatting.

[Auto overwrite]: Options Include "Disable and Auto". If a user chooses "Disable", the recording stops when the SD card is full. Once the SD card is full, it will not record again until "overwrite" is enabled. If a user chooses "Auto", recording continues and overwrites previous recording when the SD card is full.

2.4.6.2 Upgrade

To enter the "system Maintenance", select "upgrade"(see adjacent figure).

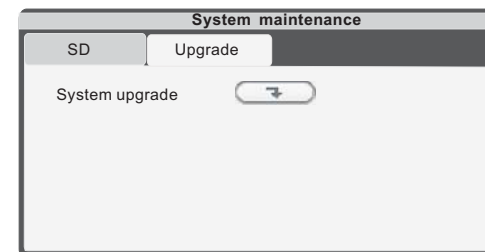

Create a new folder called "ivrupgrade" on a SD card, if its capacity is less than 64GB, its file system must be **FAT32**, and if its capacity is more than 64GB, its file system must be exFAT. Then copy the update file to the folder, and then insert it into SD port of the device. Click  to upgrade the firmware and it will display the process of the system upgrade.

Note: The system upgrade will require at least two minutes; during this time, do not remove the SD card or turn the device disable. After completing the upgrade, the device will restart.

2.4.7 User

Click "Setup"—"User"(the tab will be highlighted when selected) and single-click to enter the "User" menu. In this field, a password for accessing the indoor monitor system can be set or changed.

Login with password" indicates the password is enabled, and user must input the correct password to login the system.

After the password verification is set up (marked) the Administrator can set up to seven user passwords, as well as an Administrator password. If the password function is enabled, it will be necessary to enter the password before logging in.

Note: Once the password has been enabled, it is necessary to log in to the system as "Admin" in order to manage users; The Administrator's username ("Admin") cannot be modified.

The default password for Admin is "888888".

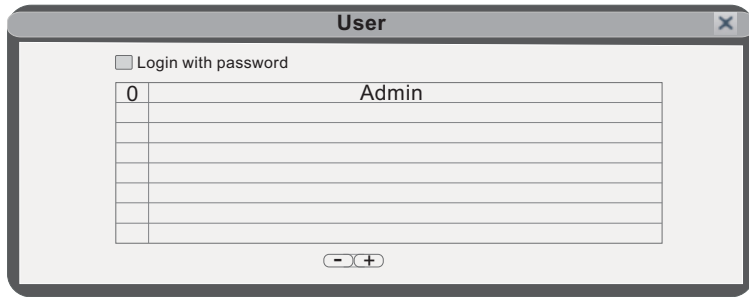

The following settings can only be set by the system administrator (who will be referred to throughout this manual as “the Administrator”; the username for the system administrator is “Admin”).

[Add Users]: Click “+” to add new users. In this window, enter the new user's name and password in the corresponding fields, and then to confirm the password, enter it a second time in the “Confirm Password” field. The length of the password must not exceed 6 digits. And user can add seven users at most. Click “Save” to save.



[Delete Users]: From this window (see the following figure), the Administrator can delete users (the color of the user has been selected will be yellow) by selecting the user of the user account to be deleted. And click “-” to enter the window to confirm.

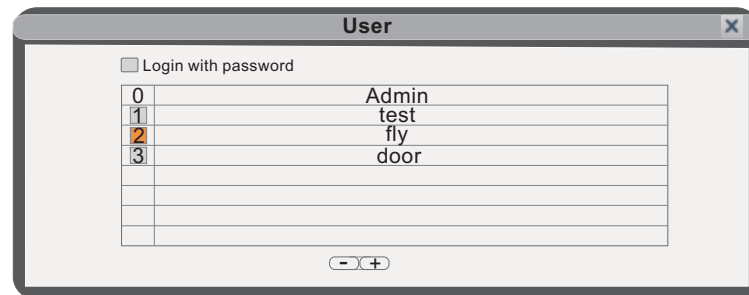

[Modify Password]: Select a user to enter the interface to modify user's password. From this window, the Administrator can change the system's password. For security reasons, before a new password can be set, it is necessary to enter the original password.

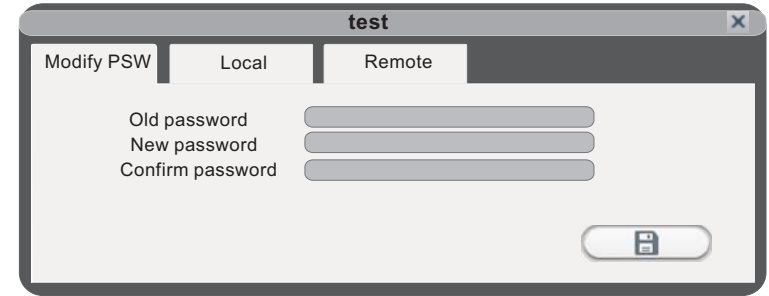

[Local Permission]: This allows the Administrator to give each user its permission to access a unique set of indoor monitor functions. That is, the Administrator can give a user access to one, some, or all of the following functions: Record, Playback, Set parameter, Ring, and Upgrade/Reboot/Maintenance/Format/Default, and the set of functions that one user is allowed to access may include functions that are different from the set of functions that another user is allowed to access (see the below figure).

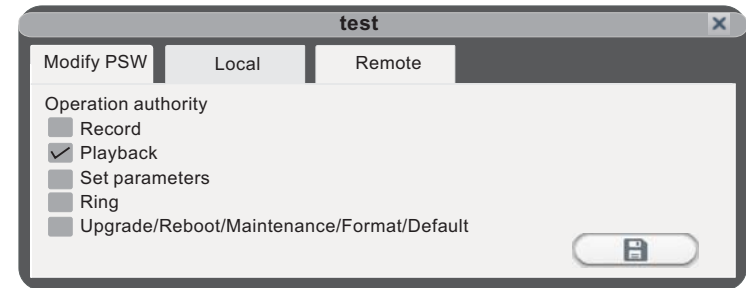

[Remote Permission]: This is a very important function for remote operation of the indoor monitor. The Administrator can use this function to set each user's remote access permissions, such as access to Playback/Download and Set Parameters from a computer that is not on the local network (see the following figure).

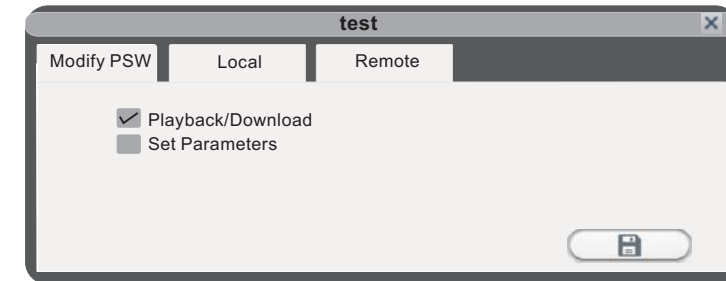

“☑” indicates that authority is enabled, “☐” indicates that authority is disabled. Click “Save” to save.

2.4.8 Default

Click "Setup"—"Default"(the tab will be highlighted when selected) and single-click to enter the "Restore to default" menu.

The system restores the default configuration status in the factory, and corresponding setting can be resumed based on options on the menu. User can select "All" to restore all the settings to the original factory settings. The options include: Time, Color and margin, Record schedule, User, Maintenance, Network, Network advanced and Alarm setup.

Prompt: The port and language can't be resumed.

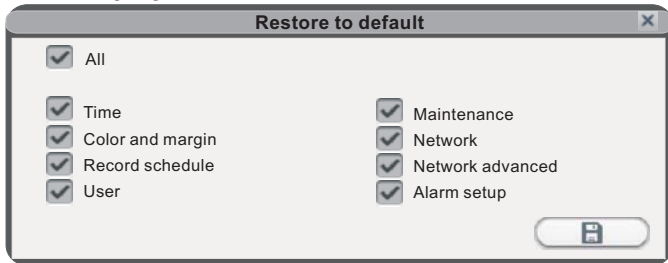

2.4.9 Information

Click "Setup"—"Information"(the tab will be highlighted when selected) and single-click to enter the "Device information" menu.

The information included accessible through this interface includes: the device ID, the software version, the release date.

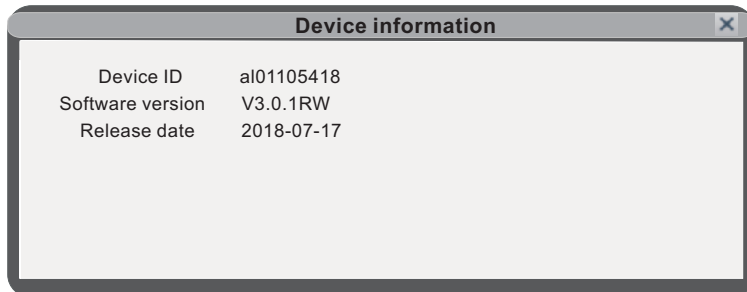

2.4.10 Save/Exit

On the "Configuration" menu, right-click or click "X" to enter the "Save" menu.

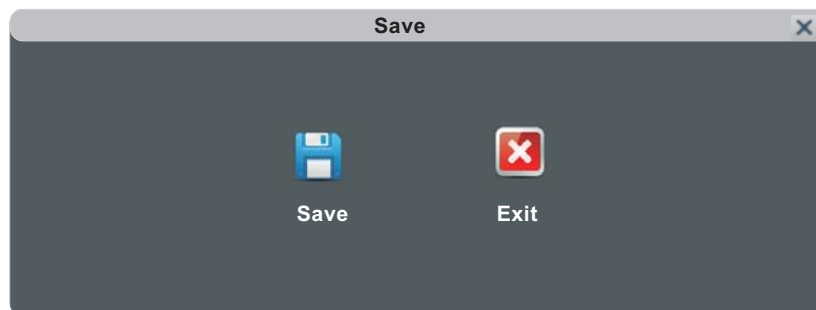

[Save]: Save all settings and exit the menu.

[Exit]: Exit the menu without saving any changes.

3. Web Browser Operation

3.1 Feature

Install the software through the Internet browser of OS to conveniently operate the network from a remote location. This device supports C/S, B/S, and access in LAN and WAN. It also supports IP and domain name visiting.

IMPORTANT! SOFTWARE RECOMMENDATIONS:

To ensure reliable remote viewing of IVR footage, it is highly recommended that users have either Windows XP, Windows 7 or Windows 8 installed on their computers, and that they use either Internet Explorer 6.0, Internet Explorer 7.0, Internet Explorer 8.0, Internet Explorer 9.0, Mozilla Firefox, or Google Chrome as their Internet browser. (In the appendix, there is an explanation of how to access the indoor unit using Firefox or Google Chrome.)

3.2 Network Security Setting

Prior to setting up remote access, set the network security level by following the following instructions:

- (1) Open the Internet Explorer browser and click the "Tools" tab located in the bar at the top of the browser; from the drop-down menu, select "Internet Options".
- (2) Click the "Security" tab in the dialogue box
- (3) Click "Custom level" (at the bottom of the dialogue box) to set the security level. .

Set the appropriate settings for the ActiveX controls and plug-ins. Find the following controls in the "Security Settings" box and select the "Enable" option for each of them. This is an extremely important step.

- * Automatic prompting for ActiveX controls.
- * Binary and script behaviors.
- * Initialize and script ActiveX controls not marked as safe for scripting.
- * Download signed ActiveX controls.
- * Download unsigned ActiveX controls.
- * Run ActiveX controls and plug-ins.
- * Script ActiveX controls safe for scripting.

Prompt: Before setting up remote access, turn Disable the firewall and any anti-virus software currently running on the computer.

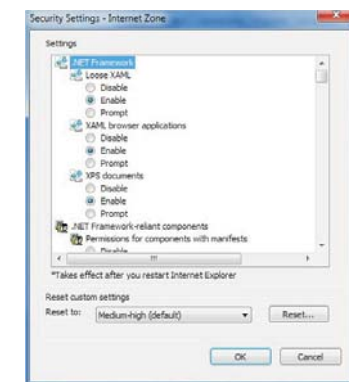
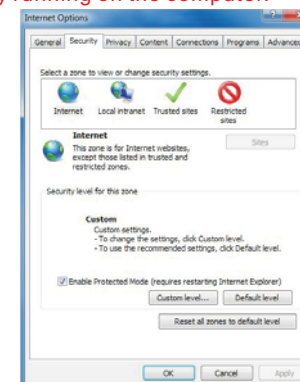

3.3 Connection Settings

Remote access to the IP video door phone is carried out over the Internet. In the local area network, the IP address of the client-side computer must be in the same network segment that the IP address of the IP video door phone. In the wide area network, the only requirement is that the two sides can visit the public network and connect to the Internet through the IP address or the dynamic domain name. The following will mainly focus on connecting and setting up the local area network.

Step 1: Right-click on “Network Neighborhood” and click “Properties” in the menu to open the “Network Connections” menu. Alternatively, if the operating system being used does not have a “Network Neighborhood” icon, enter the Control Panel found in the “Start” menu; then, click “Network and Internet”, and select “Network and Sharing Center.” On the “Network and Sharing Center” page, there should be a “Network” section; in that section, there should be a “View Status” link next to a listing that reads “Connection: Local Area Connection.” Click the “View Status” link. A small “Local Area Connection Status” window will appear; at the bottom of this screen, click “Properties”, and if prompted to give permission to continue, click “Yes.”



Step 2: Double-click to open “Local Area Connection” from the “Network Connections” menu.

Step 3: Click “Properties” in the lower-left corner of the window (see preceding figure).

Step 4: Double-click “Internet protocol (TCP/IP)” from the “This connection uses the following items” list in the center of the window (see preceding figure).

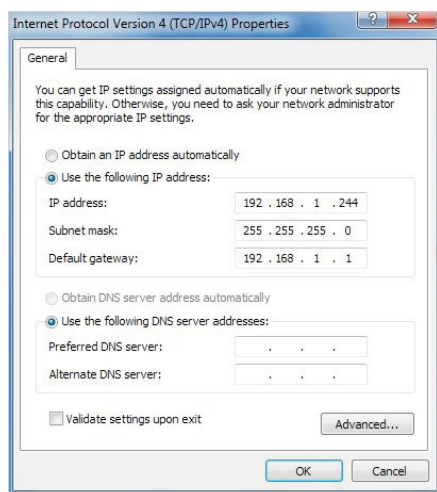
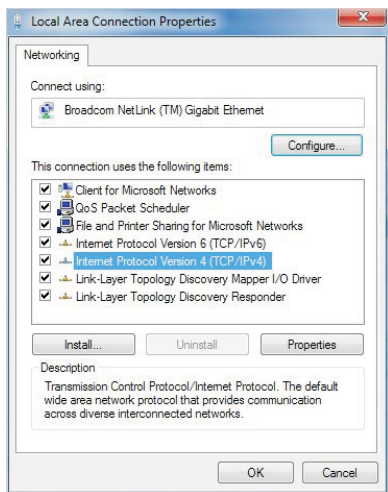

Step 5: Examine the IP address, subnet mask, and default gateway on the PC.

Step 6: Set the corresponding IP address, subnet mask, and default gateway on the indoor unit (for detailed instructions, refer to [Section 2.4.2 Network Setup](#)). If the subnet mask and default gateway on the indoor unit are the same as those of the computer, then the IP address

is most likely in the same network segment. However, they must not be exactly the same as the ones on the indoor unit, as this will cause IP address conflicts. Taking the preceding figure as an example, the IP address should be: 192.168.1.X, where X cannot be 244 or 1 (including other IP addresses currently being used), and cannot exceed 255, as the subnet mask is 255.255.255.0, and the gateway is 192.168.1.1.

3.4 Control Download and Installation

After the aforementioned settings have been adjusted and saved, open the Internet browser, enter <http://192.168.1.X> (192.168.1.X is the set IP address of the indoor unit) and confirm. If the http port of indoor unit setting has been changed (if it is not “80”), it will be necessary to add a “:” followed by a port number. For example, assuming that the current port number is “P”, enter “<http://192.168.1.X:P>”, to correct the problem.

After connecting to the internet, Internet Explorer (or other Internet browser being used) will automatically download the file to the computer as follows. Click “Install”.



The system will automatically enter the GUI as follows.



Select the English interface from the upper left side. Enter the correct password if a password has been enabled. The password is the same as the one set in indoor unit.

[USER ID]: In this field, enter the username. The default is **Admin**.

[PASSWORD]: The password is as the same as the password for the indoor unit. The default is 888888.

[NETWORK]: MAIN STREAM or SUB STREAM.

[Open Preview]: “” enable to view all the cameras automatically after the login. “” means that user needs to connect all the cameras manually after the login.

Note: If the device is connected to the WAN, the IP address should be a public IP address.

3.5 Operation Interface

Options in the main interface include “LIVE”, “PLAYBACK”, “REMOTE SETTING”, “LOCAL SETTING” and “LOGOUT.” Click any option to access it.

3.5.1 Live

Click “Live” to enter the interface as follows (in some cases, it will be necessary to click “▶” to open images from the indoor monitor).

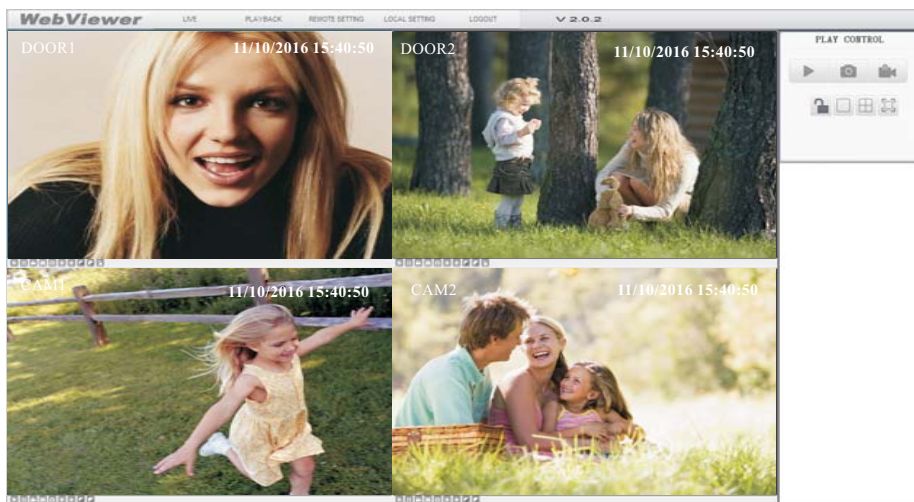

The left bottom corner of each individual channel is occupied by camera view tools:

- : Connect the current window view or close the current window view.
- : Start recording or stop recording of the current channel view. And the right bottom corner of the current channel has a normal recording video symbol “”.
- : Takes a snapshot of the displayed image.
- : Increase or decrease brightness.
- : Increase or decrease image contrast.
- : This indicates that the channel has detected motion while in motion-detection mode of the remote indoor unit.
- :Unlock for the door machine. Click this button to access the “Unlock” window(shown as below), input the correct password and click the button “” to confirm.

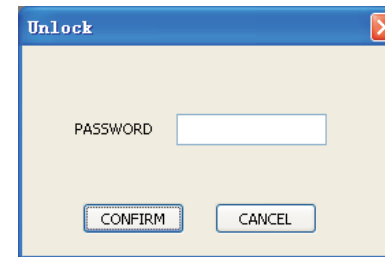

3.5.2 Controls

To use the controls, move the cursor over the icons, which will become highlighted when selected.

- / Connect all windows or disconnect all windows.
- Capture images which can be saved in a local disk (the default system save path is “c:\IVR\Capture\”).
- Quick-start to record video on all channels, and the right bottom corner of each channel has a normal recording video symbol “” (the default system save path is “c:\IVR\Record\”).
- Click this button to unlock for the door machine.

Click these icons to switch between the single-screen (), quad-split () and full-screen () options.

3.5.3 Other Operations

1. Select one channel from the preview screen (the color of the selected channel's frame will change to blue), and double-click the left mouse key will enlarge the current channel view. And single-click right mouse key as a full-screen display of the selected channel.
2. Single-click right mouse key on the preview screen will maximize all the current channels to full-screen. And single-click right mouse key again will back out.

3.5.4 Playback

Click “Playback” to enter the playback interface.

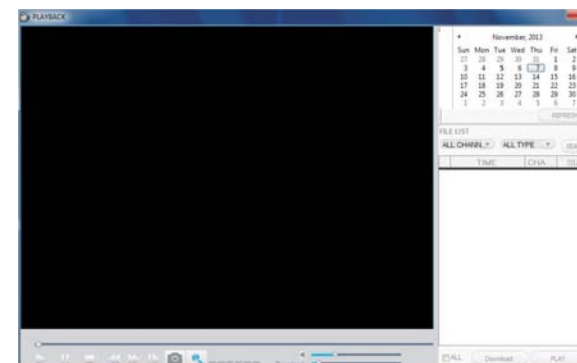

To search for a recording by date, click calendar in the upper-right corner, and use “<” and “>” to set the month of the video being searched for; click “REFRESH” (located just below the calendar) to display the recording information of current month.

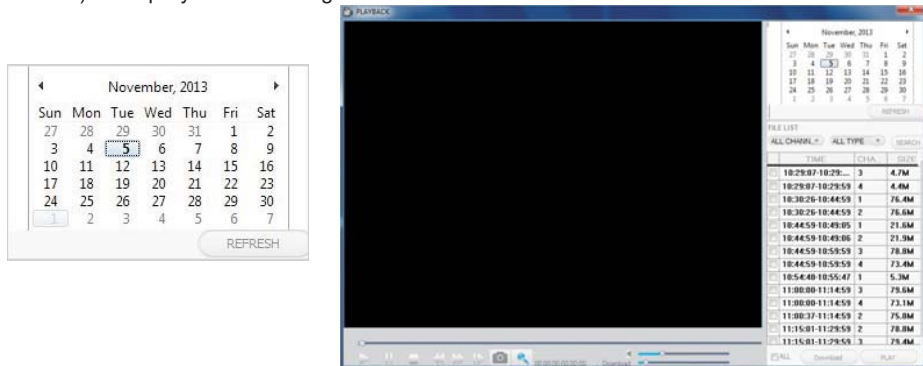

The highlighted date indicates the recording date of the video being played. Click on a date to view the recording file list for that day. For example, the preceding figure shows that there are videos on file that were recorded on November 5th and 7th (indicated by the numbers being in bold print), and is the recording file list that is currently open is the list of videos recorded on November 5th (indicated by the darker background and the “5” in white text). Another way to find a video is to select the channel and type of the file in question from the file list below the calendar. After selecting the channel and type from their respective drop-down menus at the top of the file list, click “SEARCH” and the results will be displayed in a list like the one in the following figure.

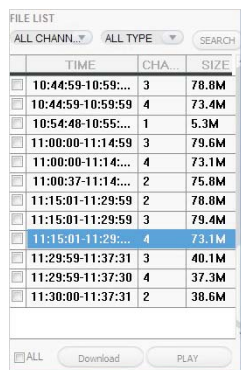

Double-click one of the listed recorded videos or select one of the listed recorded videos and then click “PLAY” to begin playback.

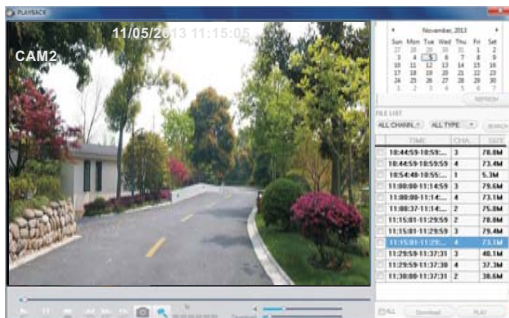

Using this button, users can download files to their computers and save them to a HDD for backup or later viewing. The downloaded file format is “AVI”. The option “” on the left side of the file is available for downloading. “” indicates the file will be saved to a HDD after clicking the “DOWNLOAD” button.

3.5.5 Toolbar Guide

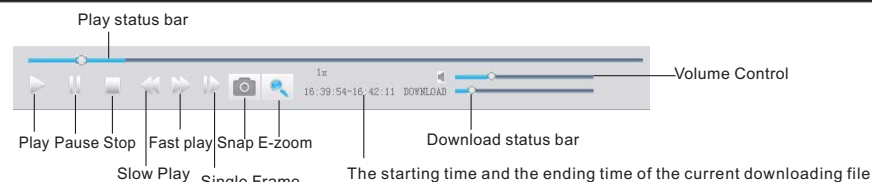

3.5.6 Remote Settings

Click “Remote Setting” to enter the “Remote Setting” setup menu. This interface includes record setting, alarm setting, network setting, advanced setting, system info, remote upgrade and user modify, which can all be modified remotely through an Internet browser.

A. Record Settings

In the sidebar on the left, click “Record Setting” to enter the recording settings menu. From this page, users can enable or disable recording for channel 3 or channel 4, set recording schedules, and adjust specific recording parameters, i.e. enabling/disabling record, and setting recording modes.

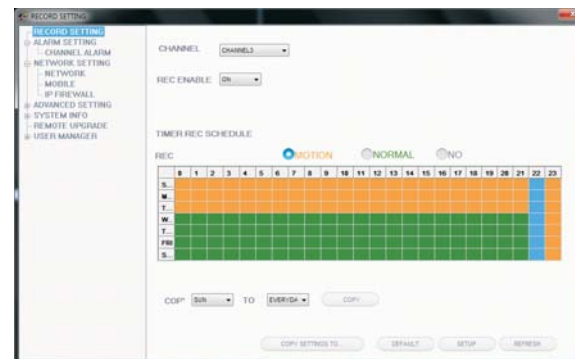

B. Alarm Settings

From the sidebar on the left, click “Alarm Setting”, then select “Channel Alarm” to enter the “Channel Alarm” setup interface. From this interface, users can set motion-detection alarms, define motion-detection privacy masking areas, motion sensitivity, and motion alarm push.

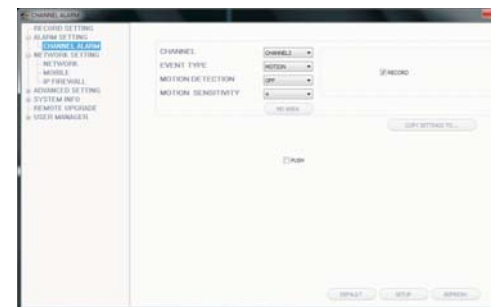

C. Network Settings

From the sidebar on the left, click "Network Setting", and then select "Network" to enter the network settings interface. The menu allows users to set basic attribute and DDNS setup.

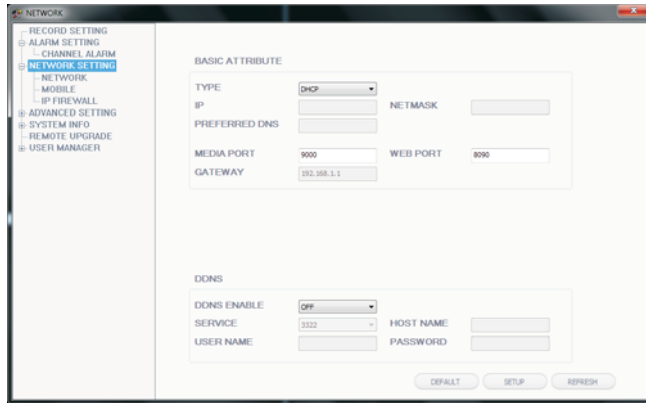

D. Mobile Settings

From the sidebar on the left, click "Network Setting", and then select "Mobile" to enter the "Mobile Settings" interface. From this page, users can set ports, push switch and push time.



E. IP Firewall

From the sidebar on the left, click "Network Setting", and then select "IP Firewall" to enter the firewall settings interface. From this page, users can turn the firewall on or Disable for specific IP addresses.



F. System Setting

From the sidebar on the left, click "Advanced Setting", then select "System Setting" to enter the system settings menu. From this menu users can find out the language and TV mode for the indoor unit.

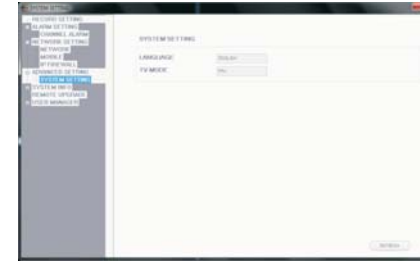

G. System Info

[Version Information]: From the sidebar on the left, click "System INFO", and then select "Version INFO" to enter the system information interface. Here, users can find out the device name, software version, and the release date.

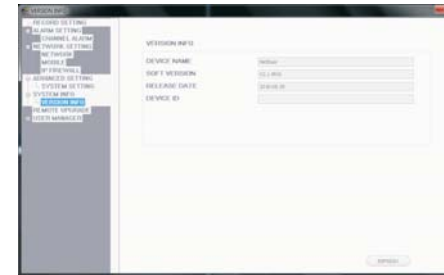

H. REMOTE UPGRADE

From the sidebar on the left, click "REMOTE UPGRADE" to enter the remote upgrade interface. Clicking "..." will select file for upgrading. Then click the "REMOTE UPGRADE" remote upgrade button in the center of the screen.

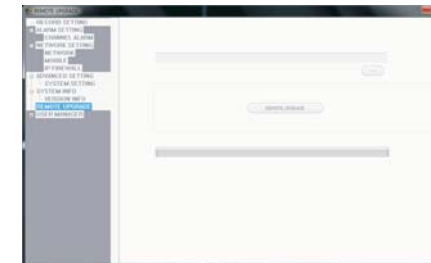

I. User Management

[ADD or DEL]: From the sidebar on the left, click "User Manager", and then select "Add or Del" to enter the add user or delete user interface. The administrator can add new users or deleted an added user.

[Modify password]: From the sidebar on the left, click "User Manager", and then select "Modify password" to enter the user management interface. Users can modify the user's password.



3.5.7 Local Settings

From the sidebar on the top, click “Local Setting” to enter the local settings interface. From this page, users can set up the save path for local settings; in the “Record Save Path” field, they can create a save path for recordings; in the “Picture Save Path” field, they can create a save path for video/still images, and in the “File Save Path” they can create a save path for downloads. Clicking “...” will set up the respective save path.



3.5.8 logout

Click “Logout” to log out of the system.

4. Mobile Phone Software Visit

This IP video door phone can transmit live feed to your mobile phone, so that you can have 'on the go' access to your surveillance system from virtually anywhere. To view, you must install a mobile operating system specific program into your mobile. Currently, there are a limited number of phones that are supported: Google Android and Apple iPhone or iPad. The Android mobile program is located on the included CD or downloaded via “Play Store”, and an iPhone mobile program or an iPad program is downloaded via “APP Store”. In “APP Store” or “Play Store”, please search for “ **IST View** ”. Please see the instruction manual for your mobile to install the program.

4.1 Iphone Mobile or Ipad

The Apple iPhone or iPad application, like all iPhone or iPad applications, needs to be downloaded directly from the App Store. Open APP store, search for “ **IST View** ”, it's a free application.

1) Through the indoor unit connection to network (or PC), and then to the indoor unit electric start.

Note: The default IP type of the indoor monitor is DHCP, for the first time PC and the device must be connected to the same router.

2) Login the app “ **IST View** ”, make sure that your smart-phone and the device are connected to the same WIFI network, press “Door Intercom Monitor”-> “Connect New Device” -> “Existing”, and press “Confirm”.

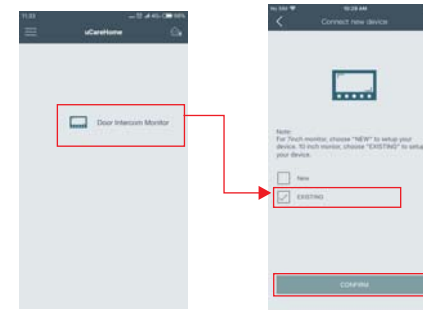

Press “LAN Search”:

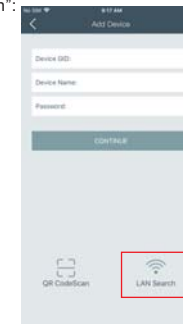

Online devices which are connected to the same WiFi router will be shown on the list(as below):

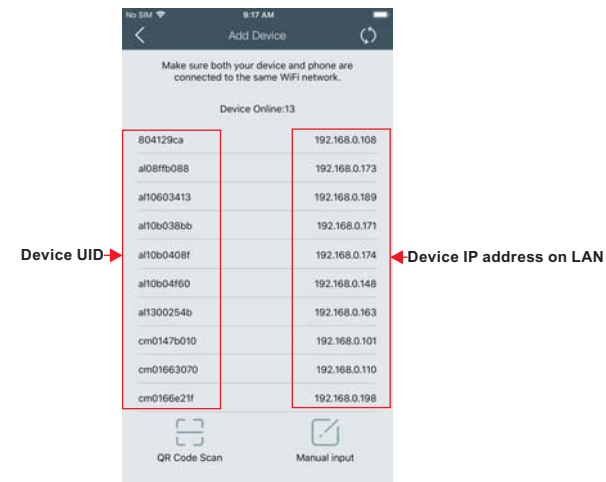

User can access to the indoor monitor by this device IP address on LAN on PC.

NOTE: For more information about the 'IST View' app, please refer to the operation manual

Appendix 1. Accessing the indoor unit via Mozilla Firefox

1. First, install Firefox on Windows(This document will use Firefox 3.6 as an example)
2. After installing Firefox, search for the "IE TAB" add-on for Firefox; this file is named "ie_tab_plus-1.95.20100930-fx+sm (IE Tab Plus (FF 3.6+).xpi)". (This file can be downloaded from the Mozilla website)
3. To install: Open Firefox, then click "Tools", and select "Privacy" and a dialog box will appear. Then choose tab which is named "Get Accessory Discreteness", and copy and paste "ie_tab_plus-1.95.20100930-fx+sm (IE Tab Plus (FF 3.6+).xpi)" into the address field. A dialog box will prompt you to install or cancel the program; choose "Install immediately." After installing the program, restart Firefox Browser.
4. Open Firefox and enter the indoor unit IP address in the address field.
5. Right-click at blank, select "Use IE TAB Plus to play this Page", and choose "Switch browser engine". The indoor unit can now be connected successfully.



Appendix 2. Accessing the indoor unit via Google Chrome

1. First, install Google Chrome on Windows(this manual will use Chrome version 7.0.517.36 as an example).
2. After installing Google Chrome, search for the "IE TAB" Chrome add-on; this file is named "extension_1_4_30_4.crx". (This file can be downloaded from the Chrome Web Store)
3. Open Chrome, enter the IP address of the indoor unit into address bar, and the following screen will appear.



4. Drag the add-on into the browser interface and the following screen will appear.

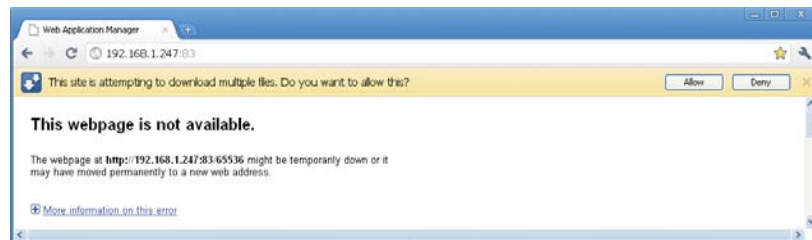

5. Select "Allow" to download multiple files and the following screen will appear.



6. Select "Continue" to continue installing extensions and the following screen will appear.

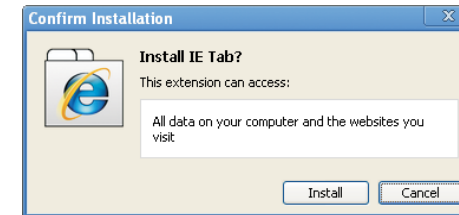

7. Click "Install" and the following screen will appear.



Note: If the web page still does not open, press the "IE" icon on the right of the address field to display this page in an IE based-tab.

8. Fill in the correct user name and password to log in.

Appendix 3. Remote Control(Optional)

Pressing the "enter" key on the remote control of the device has the same function as left-clicking a computer mouse.

Stop (■): Press this button to stop playback.

Play/Pause (▶||): Pressing this button opens the video search function and the playback menu.

When the playback mode is activated, press this button to play/pause playback.

(◀ ▶ ◀ ▶): Move selected item in menu.

Menu (MENU/ESC): Press this button to access the toolbar, hide the toolbar, enter or exit from the menu, and enter or exit sub-menus.

Numerical Buttons: Using these buttons, you can choose to display video on your monitor either as a full-screen view of each of the cameras individually (Channels 1 through 2).

ENTER: This button is used as the "enter" key in most circumstances (i.e. for selecting items from a menu).

Spot View (📍): Press this button to enable auto sequencing, and press any other button to interrupt sequencing.

Quad (📺): Press this button to switch display modes.

REC (●): Press this button to start or stop manual recording.

Appendix 4 How to ensure reliable remote viewing of the

indoor device through IE browser on Win 7/Win 8 64bit OS

1. Run 32bit IE on Windows OS (64bit)

Note: On a 64-bit version of a Windows operating system, there are two versions of the Internet Explorer files:

- * The 64-bit version is "C:\Program Files\Internet Explorer\iexplore.exe".
- * The 32-bit version is "C:\Program Files(x86)\Internet Explorer\iexplore.exe".
- * Please run the 32-bit version "C:\Program Files(x86)\Internet Explorer\iexplore.exe".



2. Run Internet Explorer as the Administrator

- 1) Open folder path "C:\Program Files(x86)\Internet Explorer".
- 2) Right click the Internet Explorer icon and choose "Run as Administrator".
- 3) Click "Continue" in the User Account Control window to grant administrator access to Internet Explorer.

3. Fix site display problems with Compatibility View

Sometimes a website you're visiting doesn't look like you expect it to. Images might not show up, menus might be out of place, and text boxes could be jumbled together. This can be caused by a compatibility problem between Internet Explorer and the site you're on. When a site is incompatible with Internet Explorer, you'll see the Compatibility View button in the Address bar. You can only turn on Compatibility View in Internet Explorer for the desktop.

A. To turn on Compatibility View

- 1) See if the Compatibility View button  appears in the Address bar. (If you don't see the  button, there's no need to turn on Compatibility View.)
- 2) Tap or click the Compatibility View button  to display the site in Compatibility View.

Once you turn on Compatibility View, Internet Explorer will automatically show that site in Compatibility View each time you visit. You can turn it off by tapping or clicking the button again. Or, you can clear the entire list of sites using Compatibility View by deleting your browsing history.

B. To clear the list of Compatibility View sites

Not all website display problems are caused by browser incompatibility. Interrupted Internet connections, heavy traffic, or problems with the website can also affect how a page is displayed. If you're having other problems on a site, such as playing videos, read Video won't play in Internet Explorer.

The Compatibility List is frequently updated, and Internet Explorer automatically downloads these update. This list includes sites that might've been designed for older or other browsers, sites that use Adobe Flash Player, and other settings that help give you a better browsing experience. If you don't want these updates, you can turn off Compatibility List Updates at any time.

C. To turn off Compatibility List Updates

- 1) Open Internet Explorer in the desktop.
- 2) Press the Alt key to display the Menu bar (or press and hold the Address bar and then select Menu bar).
- 3) Tap or click Tools, and then tap or click Compatibility View settings.
- 4) Clear the Download updated compatibility lists from Microsoft check box, and then tap or click Close.

D. To change Compatibility View settings

- 1) Open Internet Explorer in the desktop.
- 2) Press the Alt key to display the Menu bar (or press and hold the Address bar and then select Menu bar).
- 3) Tap or click Tools, and then tap or click Compatibility View settings.