

# MYDOOR™ INSTALLATION MANUAL

Intrasonic Technology, Inc. – 9525 Forest View Street, Dallas Texas – 877-435-0670  
[www.intrasonictechnology.com](http://www.intrasonictechnology.com)

MYDOOR™

# INSTALLATION

1. Ensure that the door has been powered on and connected to the home Wi-Fi *before* installation\*

Refer to the Operation Manual for the initial Wi-Fi setup instructions.

**\*INSERT MICRO SD CARD PRIOR TO INSTALLATION OF THE DOOR UNIT\***

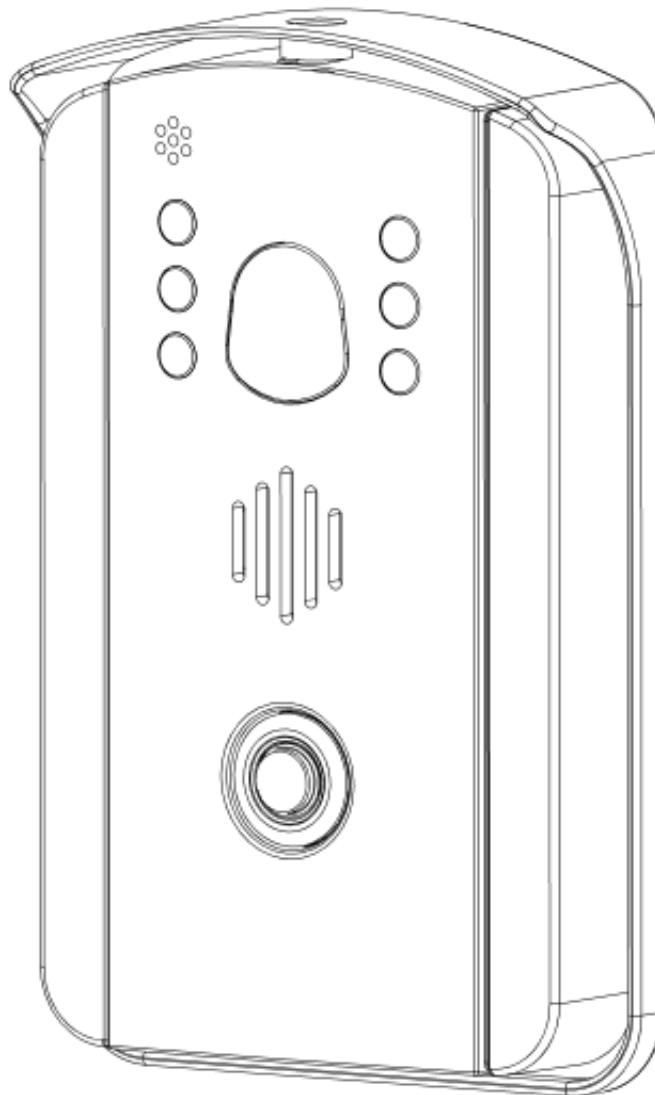

# IMPORTANT!

If connecting a home's existing 2 wires/chime box, you must use the included jumpers to short pins 1 & 2 and 3 & 4 on the 'RING' header! *See below.*

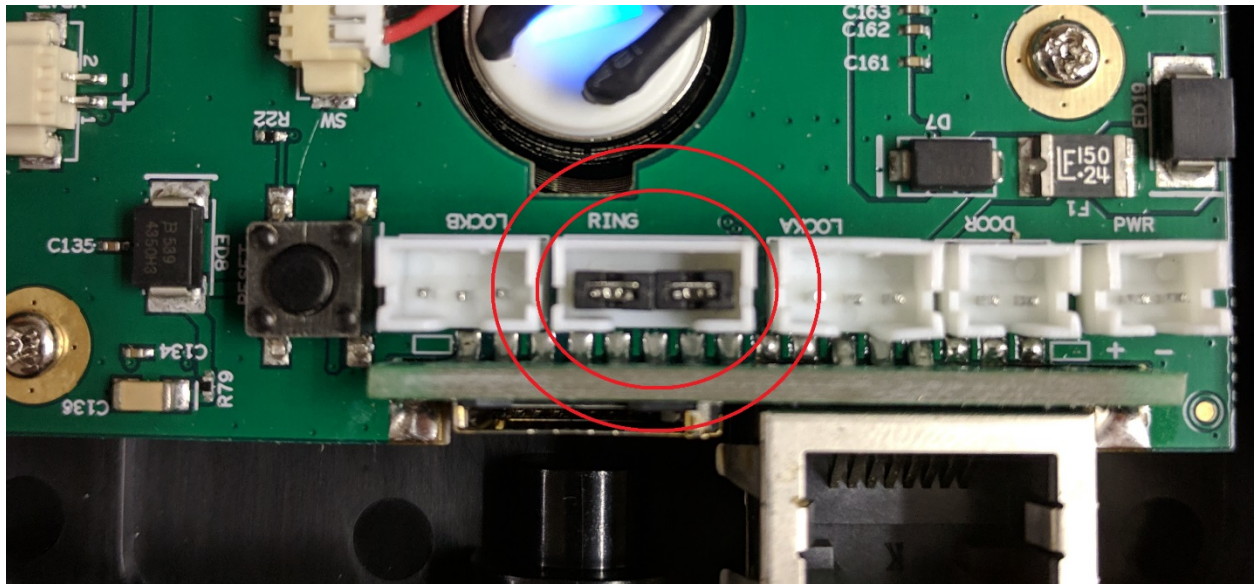

If you are *not* using the home's existing chime box and are connecting a standalone 15V transformer to power the device, the aforementioned jumpers will *not* be used. *See below.*

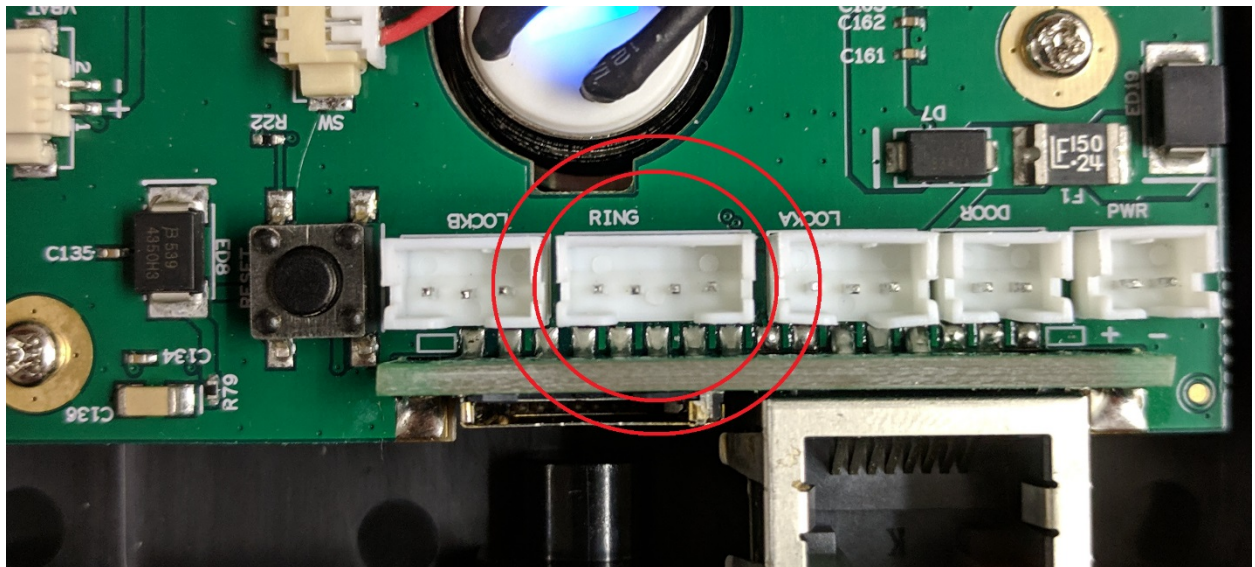

2. Now is also a good time to position the door unit where it's going to be installed so you know the angle at which the camera needs to be adjusted.  
The camera is in a ball joint-like housing. You can physically pivot the camera's viewing angle to a desired direction (see images below for reference).

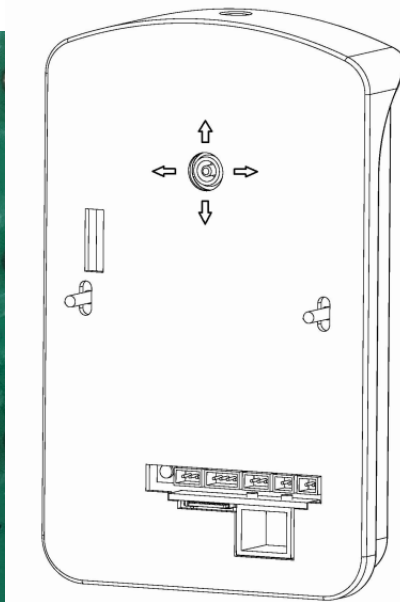
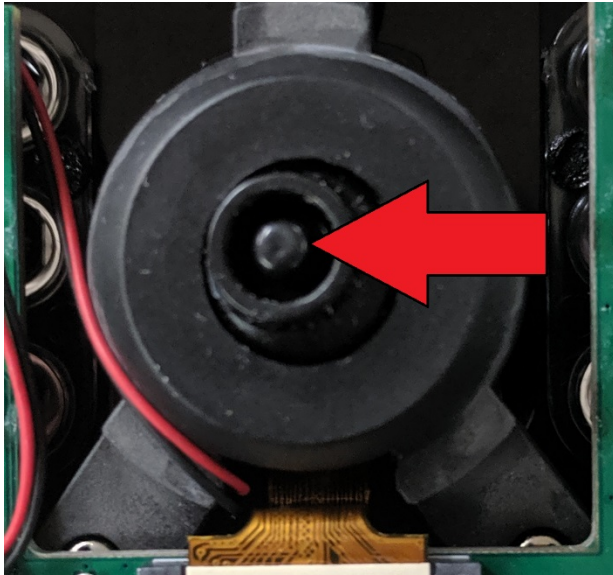

3. With the wiring routed *through* the opening of the rain guard, position the guard on the wall accordingly.

We also advise applying some sort of caulk to the top and sides of the guard (bottom open) for added weather protection\*

**The station is weather *resistant* – NOT weather *proof*!**

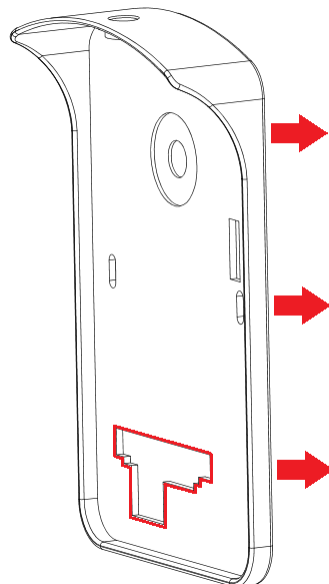

4. The MyDoor™ must then be screwed to the wall – securing the rain guard in place behind it.

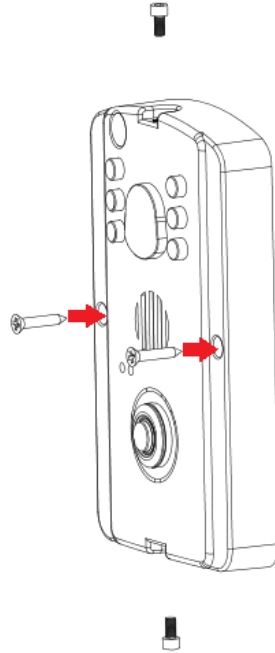

5. Lastly, position the faceplate over the MyDoor™ and secure it in place with the included bolts.

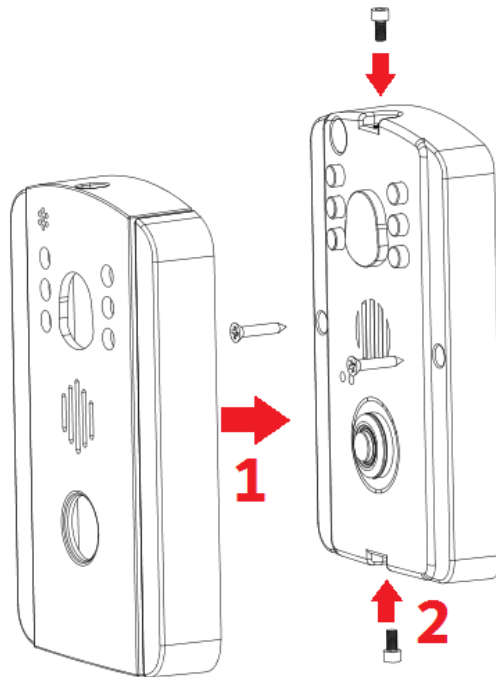

# CONNECTORS

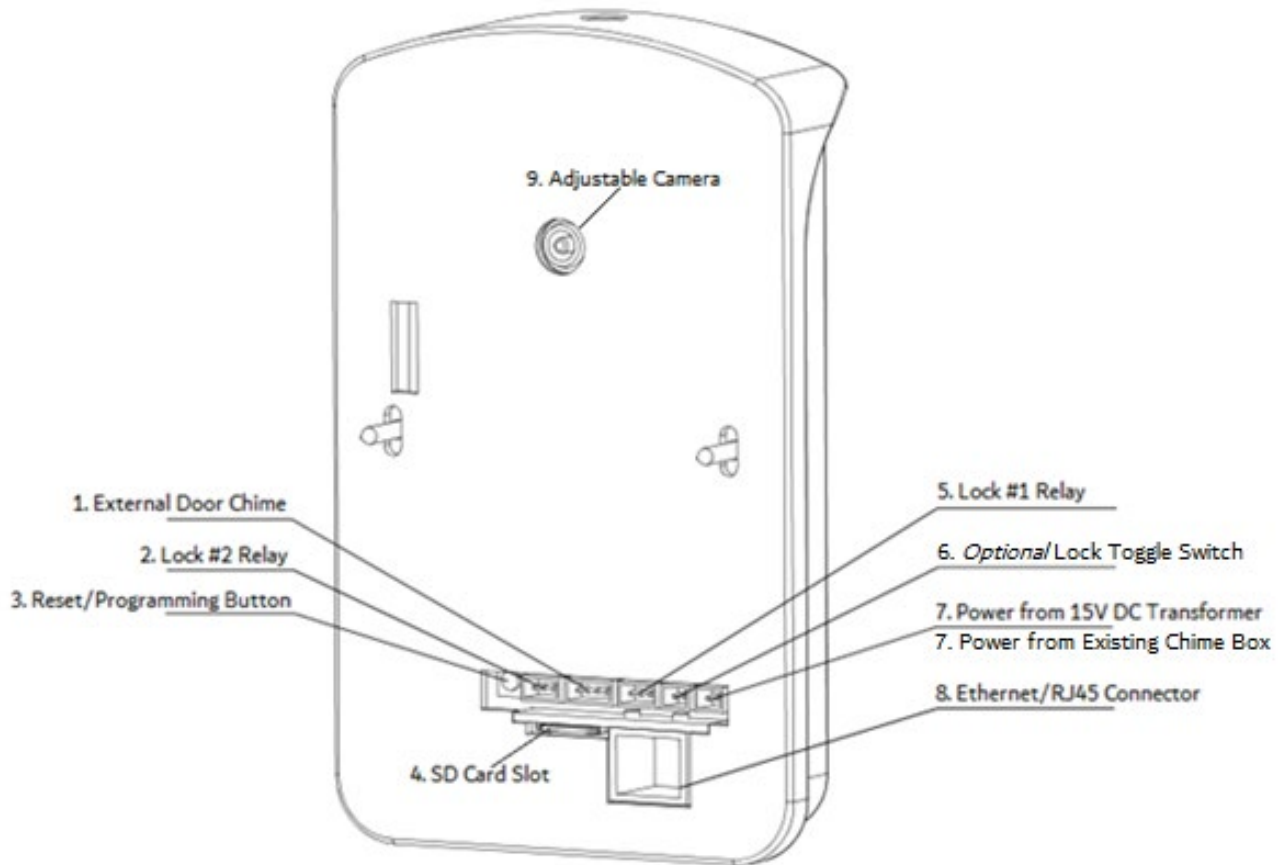

## 1. External Door Chime\_

If you're powering the MyDoor™ with a standard 15V power supply (*not* the home's existing doorbell wires/chime box), it is advisable to connect an external door chime.

You would otherwise not hear the door ring – you'd *only* get the notifications on your phone/tablet.

Any third-party door chime will work if the connection type is similar to that below\_

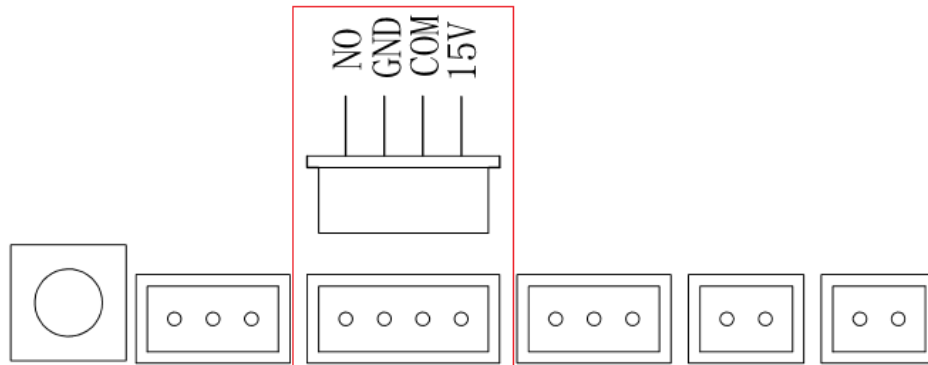

\*The external door chime will be require an external power supply

### 2. Lock #2 Relay\_

You can connect up to two locks/strikes.

The pin layout for relay #2 is as below\_

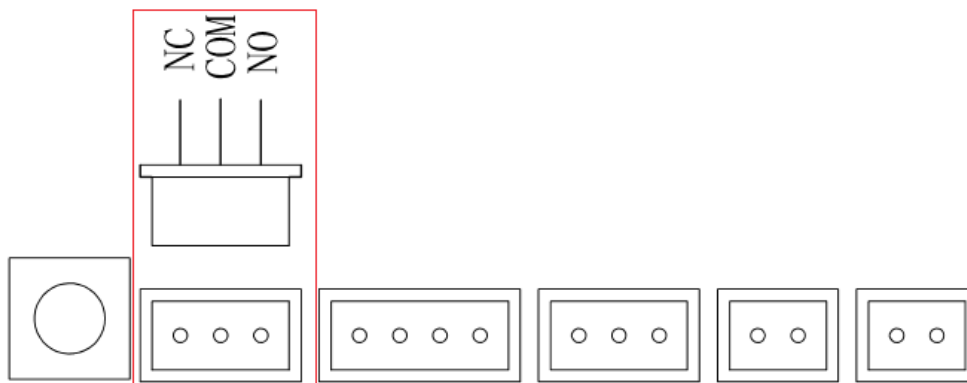

### 3. Reset/Programming button\_

This button serves as both the reset and initial programming button.

Refer to the Operation Manual for further details on the programming procedure.

**\*Holding this button for 15 seconds will reset the unit**

#### 4. SD Card Slot\_

Internal storage for the device can be expanded up to 32GB using a standard Micro SD card.

The oldest data will be overwritten as the card reaches its maximum storage capacity.

#### 5. Lock #1 Relay\_

You can connect up to two locks/strikes.

The pin layout for relay #1 is as below\_

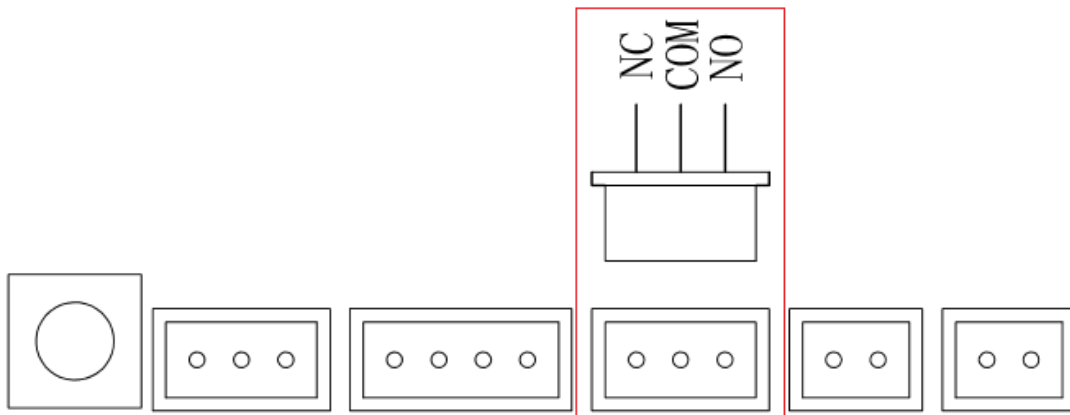

#### EXAMPLE:

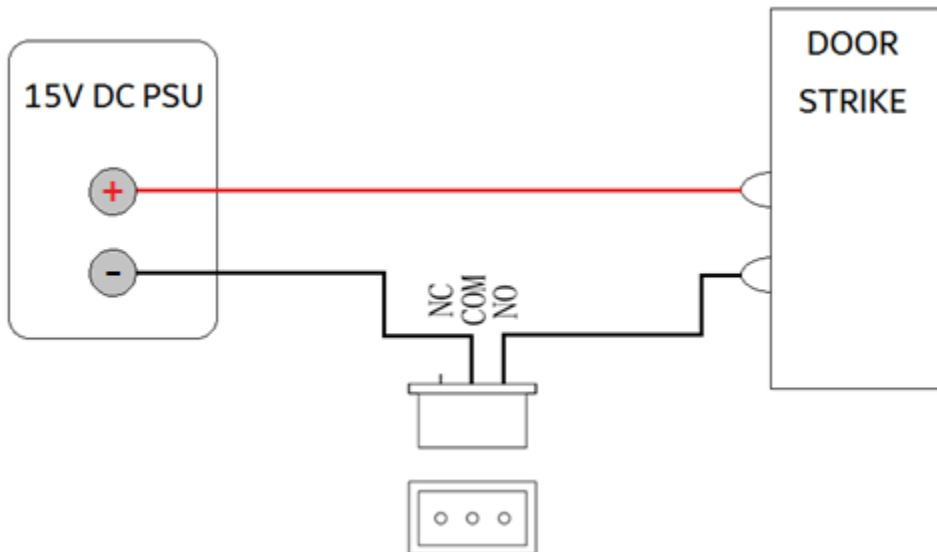



## 6. (for) Lock Toggle Switch\_

If you want to implement a push button or toggle switch to unlock the connected door strikes from *inside*, you'd do so on header #6.

An inside switch will bridge or 'jump' the two pins creating a circuit closure. This closed circuit will force the attached strikes in an unlocked position.

\*If using a momentary push button, the button must remain depressed the entire time you're wanting the door unlocked.

*The unlock action is not dependent on an internal timer.*

## 7. Power from Existing Chime Box\_

This will be used if you *are* connecting the MyDoor™ to the home's existing two wires (to the home's existing *chime box*).

Please see below for the appropriate pin layout\_

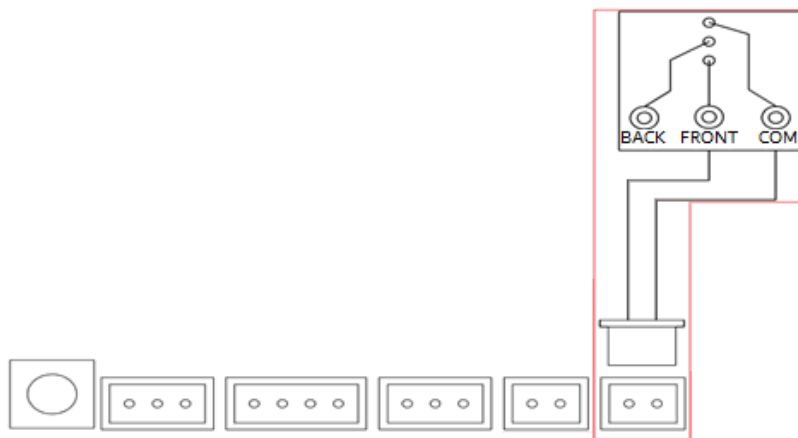

## 7. (also the #7 header)

### 15V DC Transformer\_

If this is a new installation and you're not connecting the unit up to the home's existing two-wire, you can still power the device by itself if a traditional 15V DC power supply.

It would be best to also connect an external door chime (Header #1) to still be able to hear the door ringing when the bell button is pressed.

Again, you would otherwise only get the notifications on your smart device.

The pin layout for the #7 power connector is illustrated below\_

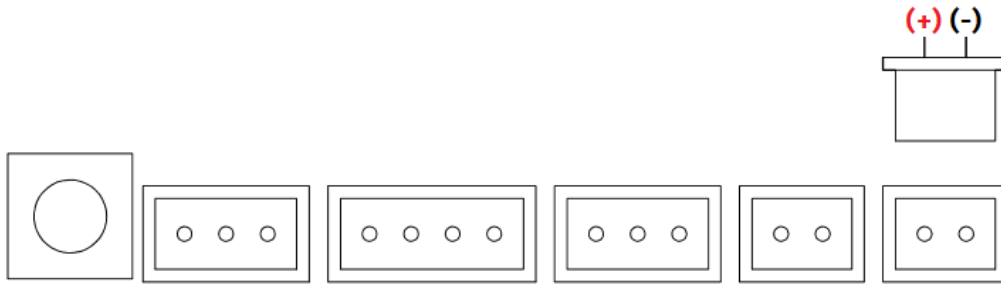

#### 8. Ethernet/RJ45 Connector\_

Connect a CAT5 cable to this port (from your home router or switch) for the best data transfer.

#### 9. Adjustable Camera\_

*Prior to installation, you can adjust the angle at which the camera is pointing.*