

ezlo

VistaCam 1203

Quick Start Guide



Video Doorbell

Congratulations on choosing the VistaCam 1203

You've taken the next step toward making your home safer and your life easier.

**It's easy to set up your camera.
Here's what you need to do.**

If you haven't already set up your Vera or Ezlo controller, please do that first. There are instructions on how to do so accompanying the controller.

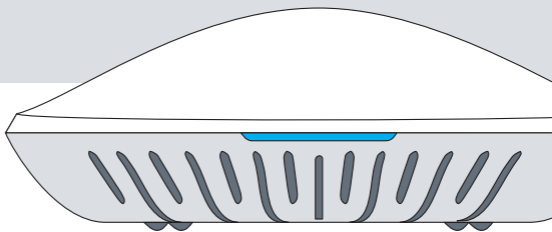

Install your app

VistaCam 1203 runs on Ezlo's Vera app. Just look for the  in the iOS App Store or on Google Play. If you already have the Vera app, just log in.

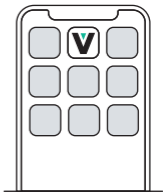

Open the Ezlo's Vera app and please sign up for a Vera account, or sign in if you have one already.

The app will take you step by step through the process, giving you the option to choose between Wired Set Up and Wireless Set Up.

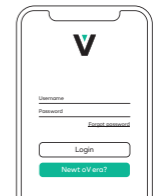

What's in the Box



1 x Video Doorbell



2 x Wire Nuts



1 x Silicone Plug



Quick Start Guide



1 x Dual-purpose screwdriver



2 x Wire Extenders



1 x Thick mounting bracket



1 x Mounting bracket



1 x 5° Vertical angle bracket



1 x 15° Horizontal angle bracket



1 x Drill Hole Position Template



1 x Power Kit



1 x Type-c cable



Option A, E 22mm (0.87")

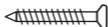

Option B, C 35mm (1.38")



Option D 45mm (1.77")

3 Sets - Expansion Screws

Physical Description

Front Panel

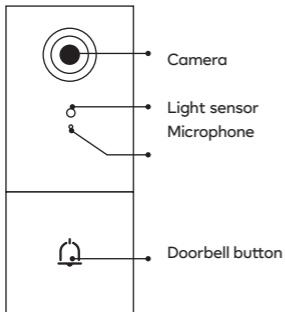

Rear Panel

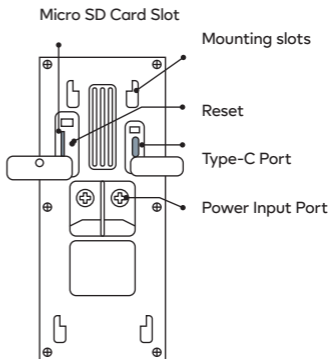

Bottom Panel

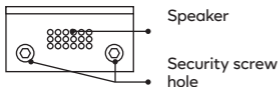

Before doing anything else, shut off the breaker that controls the doorbell's circuit.

If you have a mechanical chime installed in your home, install the power kit and doorbell.

If you have an electronic chime installed in your home, refer to its own manual to install the power kit, and install the doorbell.

If your home does not currently have chimes, please consult a local installer or contractor for assistance.

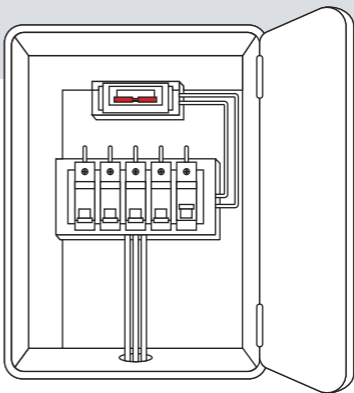

Note: The output of any newly installed wiring should be between 8-24 VAC.

Install the power kit

1 Insert one end of the wire harness into the power kit

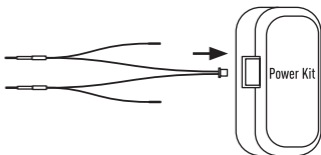

2 Remove the cover from your mechanical chime.

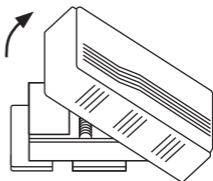

3 Remove the existing chime wires in the terminals named **TRANS** and **FRONT**.

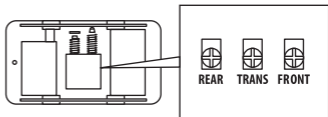

Install the power kit

4 Connect the wire harness to the chime's terminals named TRANS and FRONT.

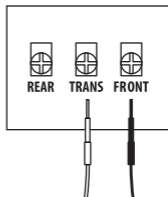

5 Insert the existing chime wire and the other end of the wire harness into the wire connector and twist it tightly. Repeat this step with the other chime wire.

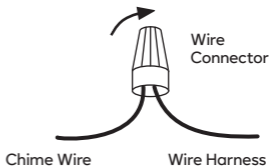

Wiring overview

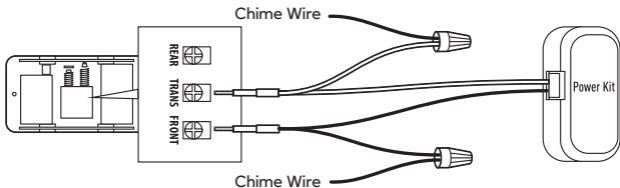

Install the power kit

6 Mount the power kit to the side of the chime.

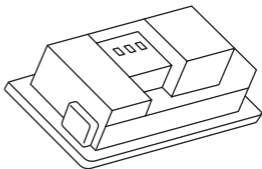

7 Put back the chime cover.

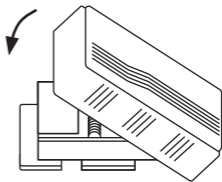

Install the doorbell

1 Ensure the electricity at the breaker that controls the doorbell's circuit is still off.

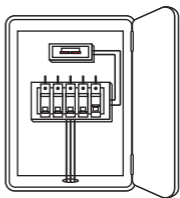

2 Place the mounting bracket where you want to mount the doorbell. A good location is at least 59 inches (1.5m) high from the ground. Then, holding the bracket in place, drill holes in the two designated areas on the bracket (at top and bottom).

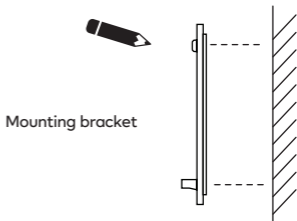

3 Drill holes according to drill points and insert anchors.

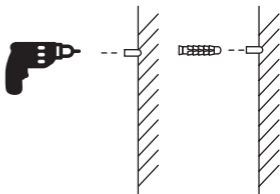

Install the doorbell

4 Fix the mounting plate to the wall.

Option A

Mounting Screws
22mm (0.87")

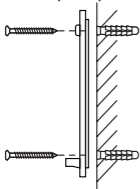

Option B

Mounting Screws
35mm (1.38")

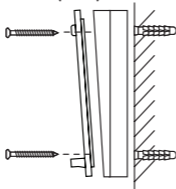

Option C

Mounting Screws
35mm (1.38")

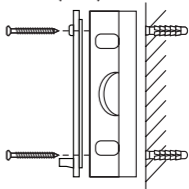

Option D

Mounting Screws
45mm (1.77")

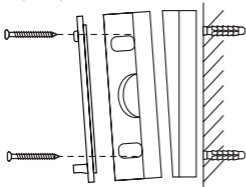

Option E

Mounting Screws
22mm (0.87")

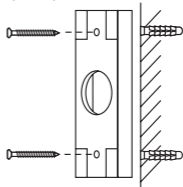

Install the doorbell

5 Connect the doorbell with your existing doorbell wires.

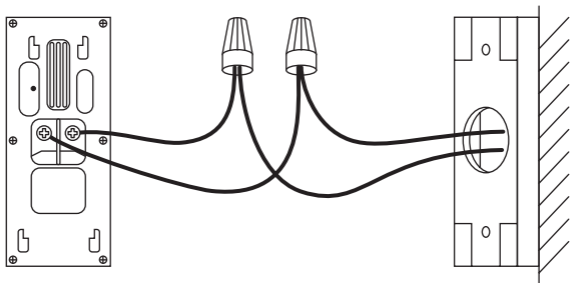

Please note that it is forbidden to connect the doorbell to AC and Type-C power supply at the same time.

Install the doorbell

6 Hook the doorbell on top of the mounting bracket and then snap the doorbell bottom to the bracket. You may hear a “click” sound.

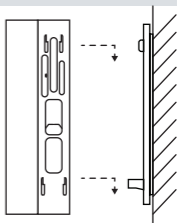

7 Use the included screwdriver to tighten the anti-theft screw.

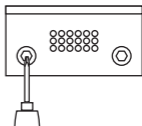

8 Restore the electricity at the breaker.

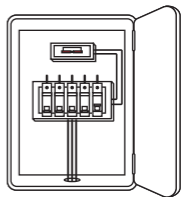

Doorbell Setup

9 In the Vera app, navigate to the Devices screen and tap + in the top right corner.

Select doorbells and look for the VistaCam 1203.

Follow the prompts to finalize the setup.



If you want to change your doorbell's Wi-Fi, press and hold the reset button for 5s and repeat the device adding process.

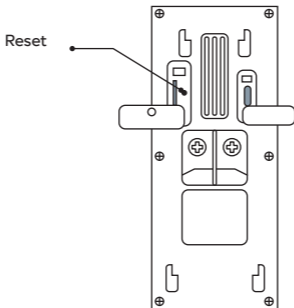

Camera model VistaCam 1203 is designed for indoor use.

FCC Information

This device complies with Part 15 of the FCC Rules. Operation is subject to the following two conditions:

- (1) This device may not cause harmful interference, and
- (2) This device must accept any interference received, including interference that may cause undesired operation.

Note: This product has been tested and found to comply with the limits for a Class B digital device, pursuant to Part 15 of the FCC Rules. These limits are designed to provide reasonable protection against harmful interference in a residential installation. This product generates, uses, and can radiate radio frequency energy and, if not installed and used in accordance with the instructions, may cause harmful interference to radio communications. However, there is no guarantee that interference will not occur in a particular installation. If this product does cause harmful interference to radio or television reception, which can be determined by turning the equipment off and on, the user is encouraged to try to correct the interference by one or more of the following measures:

- Reorient or relocate the receiving antenna.
- Increase the separation between the equipment and receiver.
- Connect the equipment into an outlet on a circuit different from that to which the receiver is connected.
- Consult the dealer or an experienced radio/TV technician for help. Please take attention that changes or modification not expressly approved by the party responsible for compliance could void the user's authority to operate the equipment.

This equipment should be installed and operated with a minimum distance 20cm between the radiator and your body.

CAUTION: RISK OF EXPLOSION IF BATTERY IS REPLACED BY AN INCORRECT TYPE. DISPOSE OF USED BATTERIES ACCORDING TO THE INSTRUCTIONS. BATTERY IS NOT USER REPLACEABLE.

Your doorbell is now set up!

You can now talk to people at your door through the Vera app and ensure greater security for your home.



You're now ready to enjoy
smarter home control.



© Ezlo Innovation 2021