



# Yale Real Living™ Key Free Touchscreen Deadbolt Installation and Programming Instructions



## NOTE TO INSTALLER

FAILURE TO FOLLOW THESE INSTRUCTIONS  
COULD RESULT IN DAMAGE TO THE PRODUCT  
AND VOID THE FACTORY WARRANTY

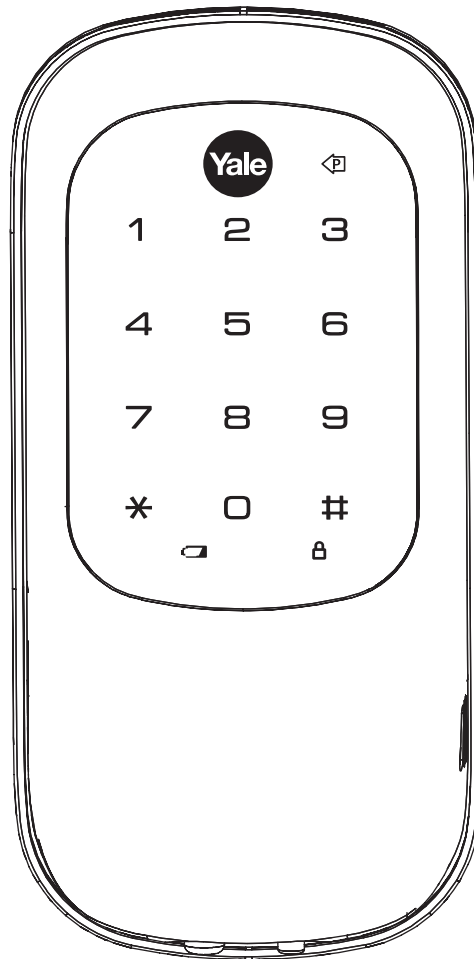

## NOTE TO INSTALLER AND CONSUMER

While Yale has included several features to prevent lockout (9-Volt battery jumper, low battery warnings), it is still possible for a lockout situation to arise. Because this product does not have a mechanical override, Yale recommends to use this product in an environment where there are additional entry points into the dwelling.

For Technical Assistance call Yale at 1-800-810-WIRE (9473)

This document is available on our website in printed Spanish and French. Go to [www.yalerealliving.com](http://www.yalerealliving.com). Click "Product Information & Documentation" and then "Installation Instructions".

Este documento está disponible en español en nuestra página de internet. Vaya a [www.yalerealliving.com](http://www.yalerealliving.com). Presione "Información del Producto y Documentación" y luego "Instrucciones de Instalación".

Ce document est disponible sur notre site Web dans le français imprimé. Allez à [www.yalerealliving.com](http://www.yalerealliving.com). Cliquez sur le " ; Information sur le produit et Documentation" et puis "Installation Instructions".

## TABLE OF CONTENTS

Warnings .....	2-3
Introduction .....	3
Installation	
Components and Tools.....	4
Prepare Lock for Installation.....	5
Install Lock.....	6-8
Programming	
Programming Features-Menu Keys-Definitions .....	9-10
Operation.....	11-14
Miscellaneous Information	
Hardware Troubleshooting.....	15
Emergency Battery Jumper .....	16
Programming Troubleshooting .....	17
Installing the Network Module.....	18
Sample Pin Code Management Sheets .....	19-20

## WARNINGS

*Warning: Changes or modifications to this device not expressly approved by Yale Security, Inc. could void the user's authority to operate the equipment.*

**IMPORTANT:** The accuracy of the door preparation is critical for the proper functioning and security of this product. Misalignment can cause performance degradation and a lessening of security.

**Finish Care:** This lockset is designed to provide the highest standard of product quality and performance. Care should be taken to ensure a long-lasting finish. When cleaning is required use a soft, damp cloth. Using lacquer thinner, caustic soaps, abrasive cleaners or polishes could damage the coating and result in tarnishing.

### **FCC:**

FCC ID: U4A-YRHCPZW0 (Z-Wave); U4A-YRHCPZB0 (Zigbee)

This equipment has been tested and found to comply with the limits for a Class B digital device, pursuant to Part 15 of the FCC Rules. These limits are designed to provide reasonable protection against harmful interference in a residential installation. This equipment generates, uses, and can radiate radio frequency energy and, if not installed and used in accordance with the instructions, may cause harmful interference to radio communications. However, there is no guarantee that interference will not occur in a particular installation. If this equipment does cause harmful Interference to radio or television reception, which can be determined by turning the equipment off and on, the user is encouraged to try to correct the interference by one or more of the following measures:

- Reorient or relocate the receiving antenna.
- Increase the separation between the equipment and receiver.
- Connect the equipment into an outlet on a circuit different from that to which the receiver is connected.
- Consult the dealer or an experienced radio/TV technician for help.

## Industry Canada:

Canadian ID: 6982A-YRHCPZW0 (Z-Wave); 6982A-YRHCPZB0 (Zigbee)

This Class B digital apparatus meets all requirements of the Canadian Interference Causing Equipment Regulations. Operation is subject to the following two conditions: (1) this device may not cause harmful interference, and (2) this device must accept any interference received, including interference that may cause undesired operation.

Cet appareillage numérique de la classe B répond à toutes les exigences de l'interférence canadienne causant des règlements d'équipement. L'opération est sujette aux deux conditions suivantes: (1) ce dispositif peut ne pas causer l'interférence nocive, et (2) ce dispositif doit accepter n'importe quelle interférence reçue, y compris l'interférence qui peut causer l'opération peu désirée.

### **For the U4A-YRHCPZB0 and 6982A-YRHCPZB0, the following statement applies:**

"This equipment complies with FCC/IC radiation exposure limits set forth for an uncontrolled environment. This equipment should be installed and operated with minimum distance 20cm between the radiator and your body. This transmitter must not be co-located or operating in conjunction with any other antenna or transmitter."

**Section 7.1.2 of RSS-GEN** Under Industry Canada regulations, this radio transmitter may only operate using an antenna of a type and maximum (or lesser) gain approved for the transmitter by Industry Canada. To reduce potential radio interference to other users, the antenna type and its gain should be so chosen that the equivalent isotropically radiated power (e.i.r.p.) is not more than that necessary for successful communication.

En vertu des règlements d'Industrie Canada, cet émetteur radio ne peut fonctionner avec une antenne d'un type et un maximum (ou moins) approuvés pour gagner de l'émetteur par Industrie Canada. Pour réduire le risque d'interférence aux autres utilisateurs, le type d'antenne et son gain doivent être choisies de façon que la puissance isotrope rayonnée équivalente (PIRE) ne dépasse pas ce qui est nécessaire pour une communication réussie.

**Section 7.1.3 of RSS-GEN** This Device complies with Industry Canada License-exempt RSS standard(s). Operation is subject to the following two conditions: 1) this device may not cause interference, and 2) this device must accept any interference, including interference that may cause undesired operation of the device.

Cet appareil est conforme avec Industrie Canada RSS standard exemptes de licence(s). Son fonctionnement est soumis aux deux conditions suivantes: 1) ce dispositif ne peut causer des interférences, et 2) cet appareil doit accepter toute interférence, y compris les interférences qui peuvent causer un mauvais fonctionnement du dispositif.

## INTRODUCTION

The Yale Real Living™ Stand-alone Key Free Touchscreen Deadbolt Lock combines a robust lockset with a contemporary electronic aesthetic.

Users benefit from an interactive touchscreen that makes day-to-day access effortless, as well as offering voice-guided programming for simple updates to user information in the event of staffing changes or security breaches. Yale Real Living™ is engineered for quick and easy installation and fits in place of a standard deadbolt lock door prep (ANSI/BHMA A156.115).

If this is an RF-enabled network lock, it needs to be located within 30 - 50 feet of another network controller or a repeating device. That distance is influenced by objects between the lock and the controller and may be expanded depending on proximity to other RF network devices. Also, if the lock is connected to a network controller, it is recommended that it is programmed through the centralized user interface (PC or hand-held device) to ensure communication between the lock and the controller unit.

# INSTALLATION

## COMPONENTS AND TOOLS

### Included in the box . . .

- |  |  |   |
|--|--|---|
| <input type="checkbox"/> Quick Start Guide         | <input type="checkbox"/> Inside Escutcheon       | <input type="checkbox"/> Bolt                   |
| <input type="checkbox"/> Installation Instructions | <input type="checkbox"/> Inside Mounting Plate   | <input type="checkbox"/> Strike Plate           |
| <input type="checkbox"/> Door Marker               | <input type="checkbox"/> Battery Cover           | <input type="checkbox"/> Screw Pack (see below) |
| <input type="checkbox"/> Outside Escutcheon        | <input type="checkbox"/> 4 AA Alkaline Batteries |   |

### Parts Illustrations

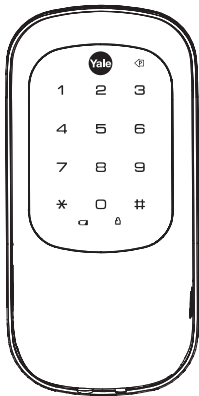

Outside Escutcheon

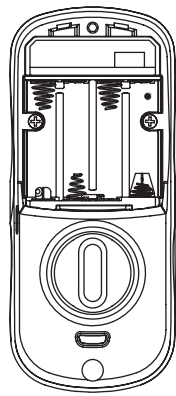

Inside Escutcheon



Battery Cover

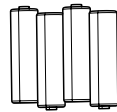

4 AA Alkaline Batteries

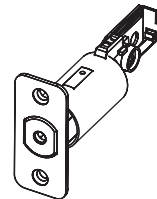

Bolt



Strike Plate

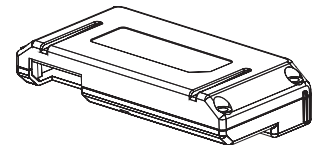

Network Module (Optional)

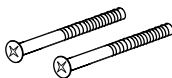

(2) Through bolts



(3) Inside Escutcheon Mounting screws

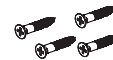

(4) Bolt & Strike Plate Mounting Screws

### Tools Needed

#### Door Prep

- 2-1/8" (54mm) hole saw
- 1" (26mm) boring bit
- 7/64" (2.5mm) drill bit
- Chisel & hammer

#### Lock Installation

- #2 Phillips screwdriver

## PREPARE LOCK FOR INSTALLATION

### Unpack the Lock

The lock is packed representative of how it will install on the door.

Before installing the lock on the door:

#### A. Inside escutcheon

1. Loosen the screw (Phillips #2) holding the battery cover. (The screw remains attached to battery cover)
2. Slide the battery cover up and out (note the two tabs at bottom of battery cover).
3. Remove the inside mounting plate (with gasket) from the back (door side) of the inside escutcheon.

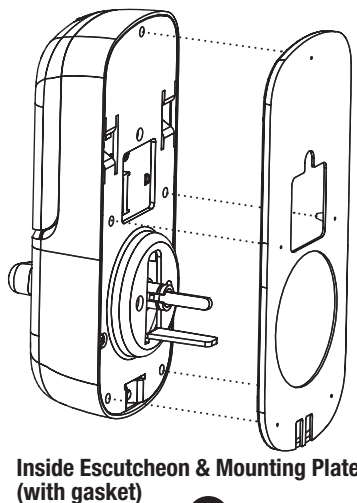

3

- a. Ensure that gasket on inside mounting plate is properly fitted. Note the positioning of the gasket's five rubber nubs (Figure 3A).

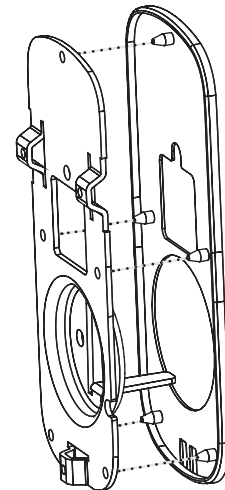

#### B. Bolt

Note: Bolt ships with backset in 2-3/8" position. If required, press small black button on underside of bolt and pull to extend to 2-3/4" backset position (Fig.3B).

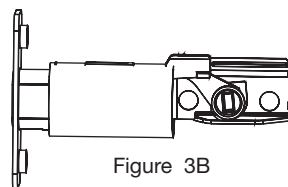

C. The outside escutcheon (with gasket) remains assembled.

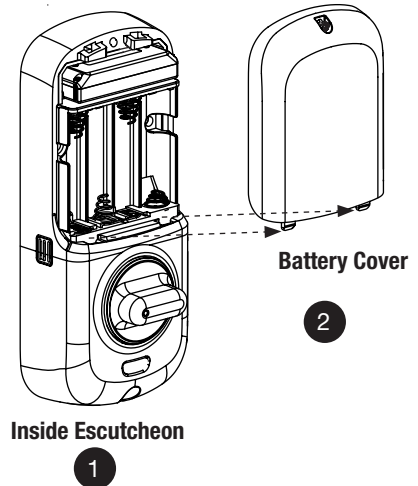
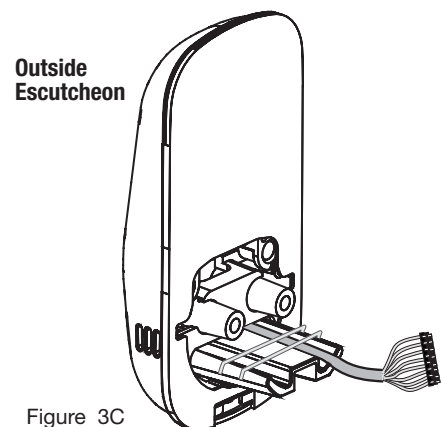

## INSTALL LOCK

1. Install bolt in door.

**NOTE: The bolt must be in a retracted (unlocked) position when installing the lockset.**

Attach with two (2) M4 x 25.4mm [8-32 x 1"] screws supplied.

2. Install strike on the door frame, making sure to allow for the bolt to be centered in the strike.

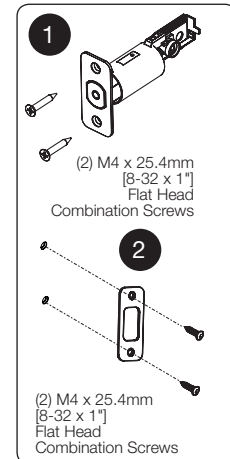

3. Install outside escutcheon.

As you position the outside escutcheon, route the wire harness through 2-1/8" diameter hole (Figure 3A).



**NOTE: Wire harness goes under bolt (Fig. 3B).**

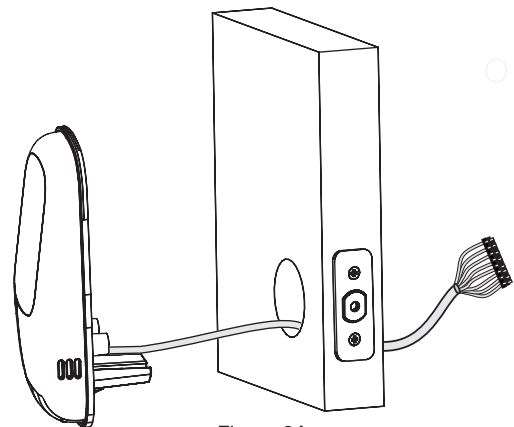
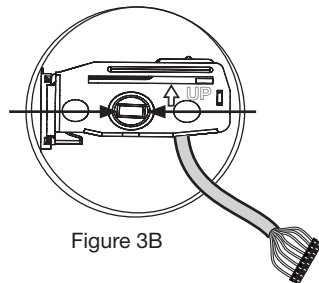

4. Holding the outside escutcheon flush to the door, position the inside mounting plate by first routing the wire harness through the mounting plate's 1/2" hole (Fig. 4A), then inserting mounting plate "tongue" into groove at bottom of outside escutcheon.

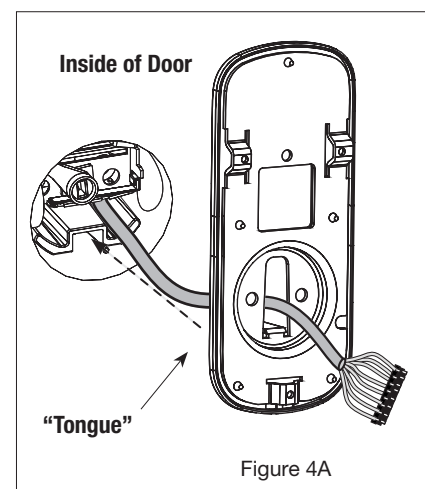

5. Secure both assemblies using (2) M6 x 59.5mm pan head machine screws (Fig. 4B), making sure that outside escutcheon is vertically aligned. Hand-tighten until snug.

**Do not over-tighten.**

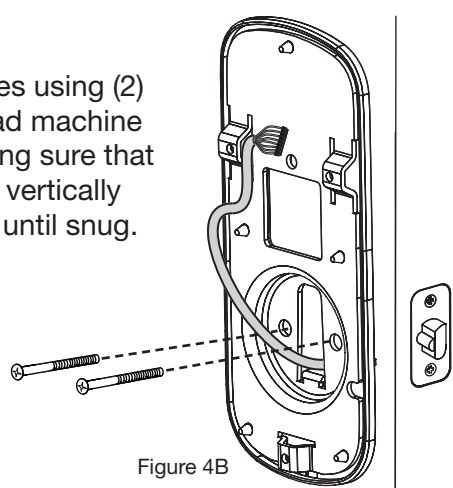

**CAUTION:**

Position and bend cable, using care when assembling to ensure that the cable lies against the back recessed area of the inside escutcheon.

Use the cable hook (Note label on circuit board) as shown in Figures 6A & 6B to prevent binding when installing the escutcheon over the mounting plate.

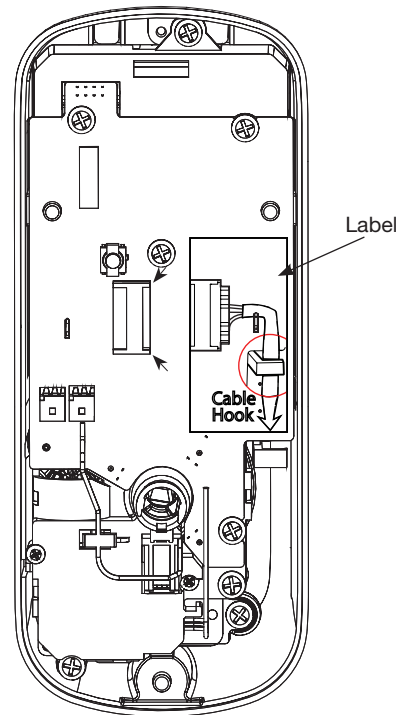

Figure 6A

- 6. Attach cable assembly connector to the inside escutcheon PC board by lining up notches on top of cable connector to slots on PCB connector (Fig. 6B).

**NOTE:** Connector should be pressed in firmly using thumbs until completely seated.

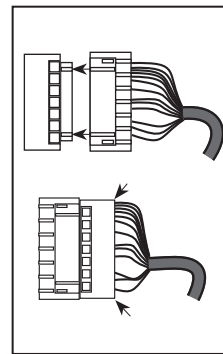

Figure 6B

Proper position is indicated by arrows on PCB as in Figures 6A, 6B and 6C.

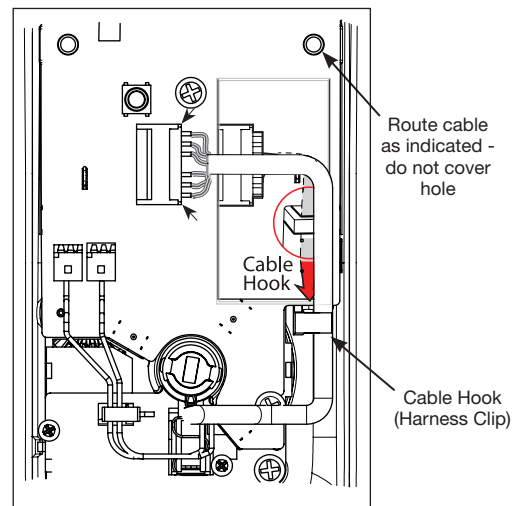

Figure 6C

7. Install inside escutcheon on inside mounting plate.

Note the horizontal orientation of the tailpiece (Fig. 7) as you insert the inside escutcheon; **the thumbturn should be vertical.**

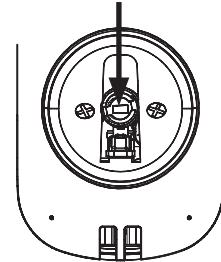

Figure 7

8. Install and secure using (3) M4 x 8mm [8-32 x 5/16"] pan head screws through the inside escutcheon into the mounting plate (Fig. 8).



**IMPORTANT:** Before installing the batteries, test the **mechanical** operation of the lock by operating the thumbturn. The movement of the bolt should be smooth and unobstructed.

If operation is not smooth, review the previous steps to ensure proper installation.

**NOTE: The bolt must be in a retracted (unlocked) position prior to installing the batteries.**

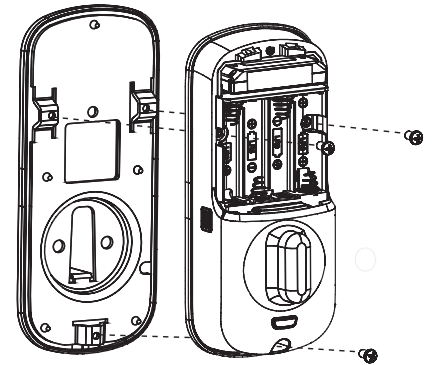

Figure 8

9. Insert four (4) AA alkaline batteries. The lock will flash, beep several times and respond with the vocal prompt: **"Welcome to Yale Real Living"**.

When activating the lock for the first time, the lock will adjust for proper handing.

**Note: Refer to programming instructions in following section prior to completion of next step (10).**

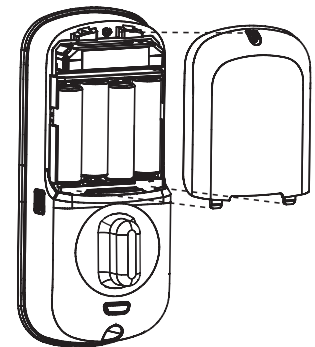

Figure 9

10. Install battery cover and tighten Phillips head screw.



# PROGRAMMING

Programming Features-Menus-Keys-Definitions ..... 9-10  
 Operation ..... 11-14

## PROGRAMMING FEATURES - MENU KEYS - DEFINITIONS

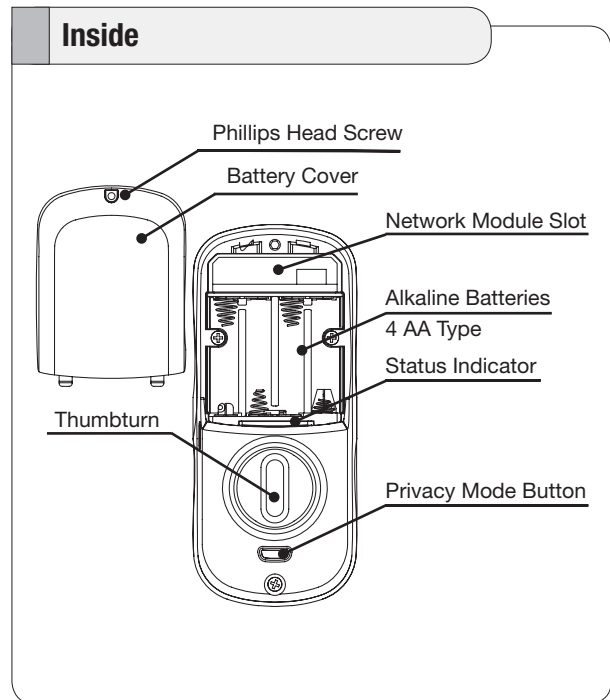
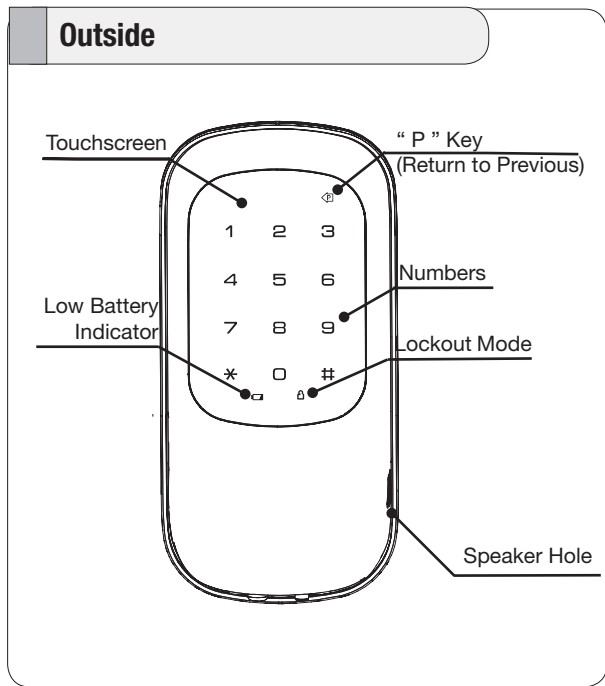

\*A unique Master PIN Code must be entered prior to any further programming of the lock. (See section on page 10 "Register Master PIN Code Before Programming")

Menu Keys and Icons Used in This Guide			
	Touch the screen with back of hand or fingers to begin and end actions.		Repeat operation using settings indicated.
	Press the indicated number.		Enter <b>Master PIN</b> code* (4-8 digits in length).
	Press the <b>Star</b> key on the touchscreen to <b>Enter</b> or <b>Accept</b> entry.		Enter <b>User PIN</b> code. Can be 4-8 digits in length.
	Press the <b>Pound</b> key on the touchscreen to enter <b>Menu</b> mode.		<b>User Number</b> (1-25); RF Network-Controlled (1-250).
	Press this key to return to the previous step or menu setting.		

## Status Indicators

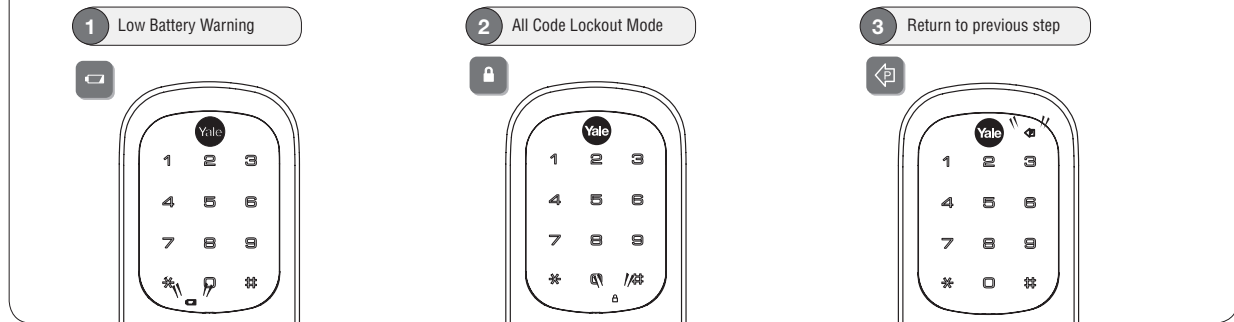

## Definitions

**All Code Lockout Mode:** This feature is enabled by the Master PIN code. When enabled, it restricts all user PIN code access (except the Master PIN code). When the unit is in Lockout Mode, the red locked padlock (see above) will appear on the screen when attempting to enter a PIN code.

**Automatic Re-lock Time:** After successful code entry and the unit unlocks, it will automatically re-lock after a default of thirty (30) seconds. Re-lock time is adjustable\* from 10-180 seconds.

**Inside Indicator Light:** Located on the inside escutcheon, it shows active status (Locked) of lock and can be enabled or disabled in the **Advanced Lock Settings** (Main Menu selection #3).

**Language Setting Mode:** Choosing English (1), Spanish (2) or French (3) becomes the (default) setting for the lock's voice prompts.

**Low Battery:** When battery power is low, the Low Battery Warning Indicator flashes RED.

**Master PIN Code:** The Master code is used for programming and for feature settings and **must be registered prior to programming the lock**. The Master code will also operate the lock.

**Network Module Setting:** With the optional Network Module installed, this setting becomes available through the Main Menu (7) and allows the lock to connect with a network controller.

**One Touch Locking:** When the latch is retracted, activating the keypad will extend the latch (during Automatic Re-lock duration or when Automatic Re-lock is disabled). When One-Touch Re-lock is **not** in use (**disabled**), any valid PIN code will re-lock the lock.

**Previous:** While in Menu Mode, pressing this icon (#3 above) cancels the current operation and returns the user to the previous step.

**Privacy Mode Button:** Pressing and holding the Privacy button (found below thumbturn) for a duration of four beeps deactivates the keypad, and because it is set from the inside, provides a secure lock for the convenience of the occupant(s).

**Shutdown Time:** The unit will shutdown (flashing RED) for a default\* of sixty (60) seconds (time is adjustable\* from 10-180 seconds) and not allow operation after the wrong code entry limit (see below) has been met.

**Tamper Alert:** Audible alarm if attempting to forcibly remove outside lock from door.

**User PIN Code:** The User code operates the lock. Maximum number of user codes is 250 with Network Module; without Network Module, maximum is 25 user codes. When deleting User PIN code(s), screen will display User Number (not PIN code) being deleted.

**Volume Setting Mode:** The volume setting for PIN code verification is set to **Low (2) by default**; otherwise it can be set to **Silent (3)** for quiet areas, or it can be set to **High (1)**.

**Wrong Code Entry Limit:** After a specified number of unsuccessful attempts at entering a PIN code the unit will shut down and not allow operation. Default is (5). Limit is adjustable\* from one (1) to ten (10) times.

\*Adjustable only when using Network Module with compatible integrated controller

## OPERATION

### Lock Activation

The touchscreen can be activated in several ways:

Touch screen with back of hand or fingers to activate.

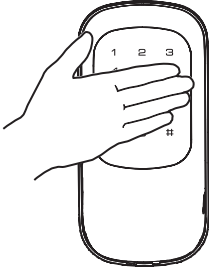

Touch screen with fingers spread to activate.

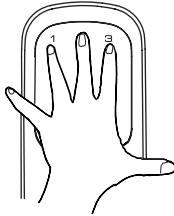

Press the \* key to activate.

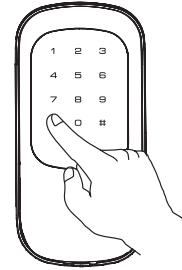

### Register Master PIN Code Before Programming\*

1. Touch the screen with the back of your hand or fingers to activate .
2. Press the 1 key.  
Lock Response: "Register Master Code; press the # key to continue."
3. Press the # key.  
Lock Response: "Enter a 4 to 8 digit PIN code followed by the pound key."
4. Enter new 4-8 digit Master PIN code followed by the # key.  
Lock visually confirms PIN code selection, announces "Registered".

\*This initial step **must** be performed upon installation or after resetting the lock to factory default. Programming and subsequent use of the lock is not possible until this step has been successfully completed.

 Touch screen with the back of your hand or fingers to activate.



Press the 1 key followed by the # key.

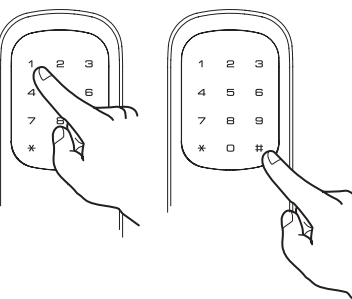

Enter the new Master PIN code (4-8 digits), followed by the # key.

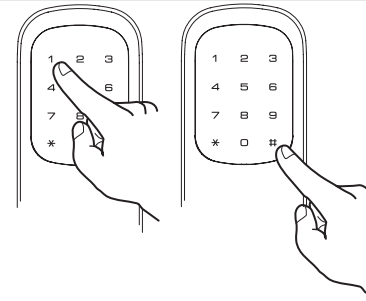

**Protect your privacy; always shield your PIN code entry.**

## To reset the lock to factory default, see the following:

### Reset Lock to Factory Default

The following procedure returns the lock to its factory defaults by deleting all user codes (**including the Master PIN code\***) and returning all programming features to their original default settings (see below).

1. Remove the batteries and then remove the interior escutcheon to access the reset button.
2. The reset button (see image at right) is located above the PCB cable connector.
3. Hold down the reset button (for a minimum of 3 seconds) and then reinstall the batteries; once the batteries are properly installed, release the reset button.

All features, including adjustable settings\*\* (see below) should now be returned to factory default.

\*Upon reset, Master Code Registration is the only option available and **must be performed** prior to any other programming of the lock.

See "**Operation**" in this manual for programming instructions.

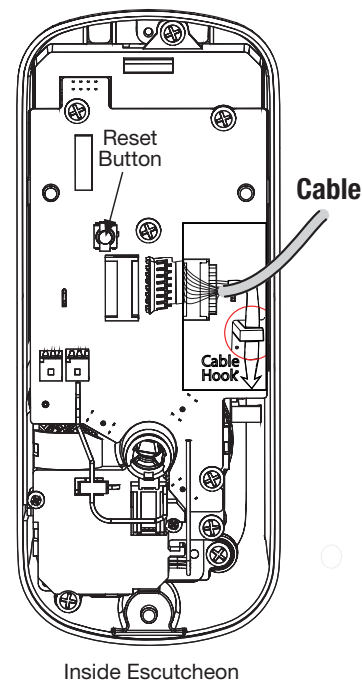

### Factory Default Settings

Settings	Factory Default
Master PIN Code	Registration <i>required*</i>
Automatic Re-lock	Disabled
Inside Indicator Light	Disabled (Off)
One Touch Locking	Enabled
Audio/Volume	Enabled (Low)
Privacy Mode	Disabled
Automatic Re-lock Time	**30 Seconds
Wrong Code Entry Limit	**5 Times
Shutdown Time	**60 Seconds

\*The Master PIN code must be registered prior to any other programming of the lock









\*\*Adjustable only when using Network Module with compatible integrated controller

## PIN code structure

Maximum number of user codes is 250 with Network Module; without Network Module, maximum is 25 user codes.

## Set Up User PIN Codes

User PIN Codes can only be programmed through the Master PIN Code\*.

1. Touch the screen with the back of your hand or fingers to activate .
2. Enter the 4-8 digit Master PIN code followed by the  key.  
Lock Response: "Menu mode, enter number, press the  key to continue."
3. Enter "2" followed by the  key.
4. Enter "1" followed by the  key.
5. Enter the User Number to be registered (1-25) followed by the  key.
6. Enter a 4-8 digit PIN code for the User number followed by the  key.
7. **To continue adding users** press the  key.
8. Press the  key to complete the process and conclude the programming session.

Note: When registering User codes, the code must be entered within 20 seconds or time expires. Lock Response: "Time expired", no codes are registered and the process must be re-started.

\*Master PIN code must be registered before User codes can be added.

## Open Door with PIN Code

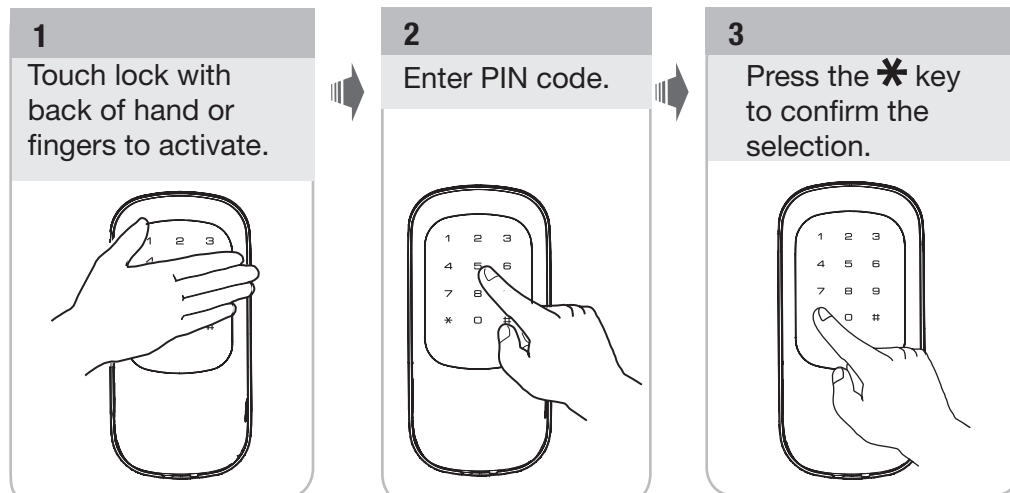

## Privacy Mode vs. All Code Lockout Mode

- All Code Lockout is a Menu feature (6) that restricts Pin code access (except Master).
- Privacy mode is set by pressing and holding the privacy button (found below thumbturn) for a duration of four beeps. This deactivates the keypad and sound, and because it is set from the inside, provides a secure and silent lock for the convenience of the occupant(s).

## Feature Programming Through Menu Mode Using Master PIN code\*

1. Enter the 4-8 digit Master PIN code followed by the # key.
2. Enter digit corresponding to the function to be performed followed by the # key.

Note: If the lock is connected to a network controller, it is recommended that it is programmed through the centralized user interface (PC or hand-held device) to ensure communication between the lock and the controller unit.

\*The Master PIN code must be registered prior to any other programming of the lock.

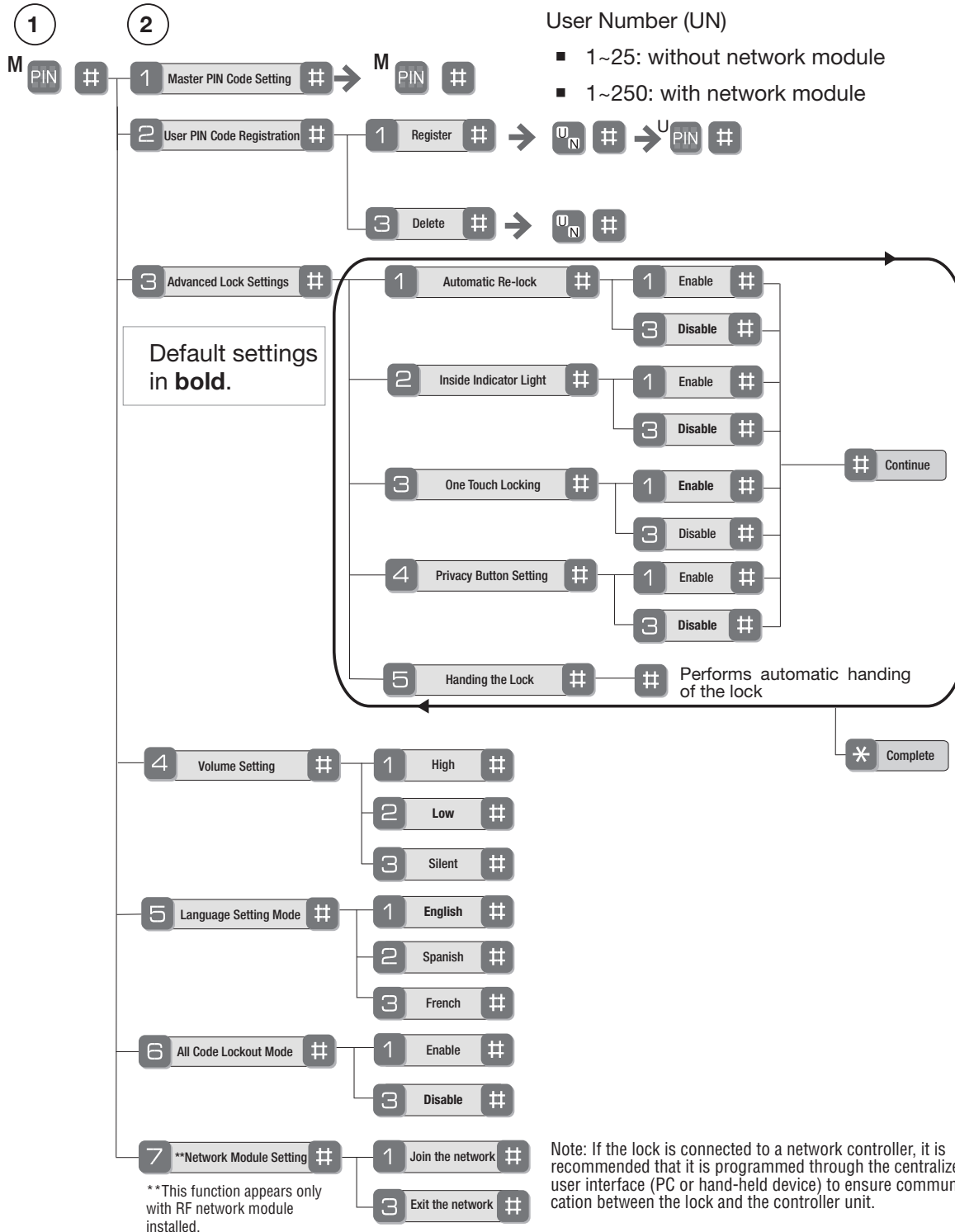

# MISCELLANEOUS

Hardware Troubleshooting .....	15
Emergency Battery Jumper .....	16
Programming Troubleshooting .....	17
Installing the Network Module .....	18
Sample Pin Code Management Sheets .....	19-20

## TROUBLESHOOTING

### Hardware Troubleshooting

Cycle the lock in both the locked and the unlocked positions. If problems are found:

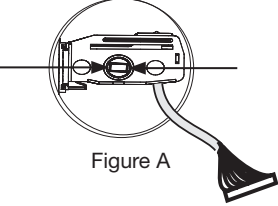
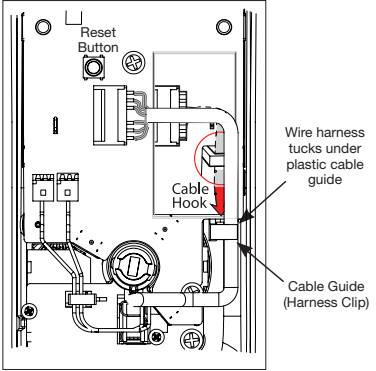
Symptom	Suggested Action
Door is binding	<ul style="list-style-type: none"> <li>a. Check that door and frame are properly aligned and door is free swinging.</li> <li>b. Check hinges: They should not be loose or have excessive wear on knuckles.</li> </ul>
Bolt will not deadlock	<ul style="list-style-type: none"> <li>a. Check for sufficient clearance of the bolt within the strike-side jamb. Correct this by increasing the depth of the pocket for the bolt.</li> <li>b. Check for misalignment of bolt and/or strike which may be preventing bolt from properly entering the strike. With the door open, extend and retract the bolt; if it is smooth, check the strike alignment.</li> </ul>
Bolt does not extend or retract smoothly	<ul style="list-style-type: none"> <li>a. Bolt and strike are misaligned, see above.</li> <li>b. Check the backset of door relative to adjustments already made to bolt.</li> <li>c. Verify proper door preparation and re-bore holes that are too small or misaligned.</li> <li>d. Verify keypad wire harness is routed under the bolt (see Fig. A).</li> <li>e. Verify bolt is installed with correct side up (Fig. A).</li> </ul> <div style="text-align: center;">  <p>Figure A</p> </div>
Keypad numerics are scrolling	<p>Remove interior escutcheon and check to ensure that the wire harness lies flat against the back recessed area and is properly routed along the side of the escutcheon and tucked under the plastic cable guide.</p> <div style="text-align: center;">  </div>

## Emergency Battery Jumper

Should the lock's installed batteries fail, a 9V battery can be held against the jumper found at the bottom of the outside escutcheon (Fig. A), providing sufficient current to enter a valid code that unlocks the door.

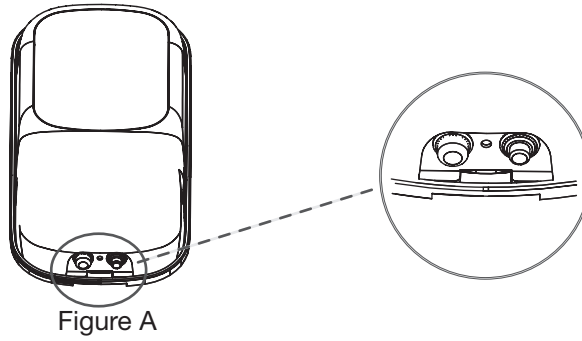

Figure A



## Programming Troubleshooting

Symptom	Suggested Action
Lock does not respond – door is open and accessible.	<p>The touchscreen will become active when pressed with the back of hand or fingers in at least 3 areas simultaneously.</p> <p>Use a larger area of the hand or fingers and verify contact with at least 3 areas.</p> <p>If touchscreen numbers are visible, check to see if they respond when pressed.</p> <p>Check batteries are installed and oriented correctly in the battery case.</p> <p>Check batteries are in good condition; replace batteries* if discharged.</p> <p>Check to see if touchscreen wire harness is fully connected and not pinched.</p>
Lock does not respond – door is locked and inaccessible.	Lock may be in Privacy mode (set from inside room). Batteries may be completely discharged.
The unit is on for a while, and then shows no reaction. Lights dim.	The batteries do not have enough power. Replace the batteries*.
Unit chimes to indicate code acceptance, but the door will not open.	<p>Check to see if there is an existing lock device on the door.</p> <p>Check the door gaps for any foreign objects between door and frame.</p> <p>Check that the wire harness is firmly connected to the PCB.</p>
Unit operates to allow access, but will not automatically re-lock.	<p>Automatic Re-Lock has been disabled; enable in Menu Mode Advanced Settings.</p> <p>If low battery indicator is lit, replace batteries*.</p>
PIN codes will not register.	<p>Registration/management of PIN codes is set by the authority of Master Code.</p> <p>The Master PIN code must be registered prior to adding any users.</p> <p>PIN codes must consist of 4 to 8 digits to register.</p> <p>The same PIN code cannot be used for multiple users.</p> <p>Contact the Master user.</p> <p>User codes must be entered within 5 seconds (while the touchscreen is active) or the process will have to be restarted.</p> <p>The star * (*) or pound # (#) can not be used as part of the PIN code.</p>
Upon entering a PIN code and pressing the star (*) key, the unit displays an “invalid code” error or the lock times out without responding.	<p>All Code Lockout Mode is enabled.</p> <p>Only the Master Code can enable All Code Lockout Mode.</p> <p>Contact the Master user.</p>
Upon entering a PIN code and pressing the (*) key, the red padlock icon appears and there are different tones.	<p>Check to see if lock is set** at All Code Lockout Mode.</p> <p>Setting/managing All Code Lockout Mode is done through Master Code only. Contact the Master user.</p>
The unit operates, but it makes no sound.	Check to see if Silent Mode is enabled (pages 8, 11).
The unit responds “Low Battery”	This is the voice alarm alerting that it is time to replace the batteries. Replace all four (4) batteries with new AA Alkaline batteries*.
Upon entering a PIN code and pressing the star (*) key, the unit responds “Wrong number of digits.”	The digits entered were incorrect or incomplete. Re-enter the correct code.

\* When batteries are replaced, Network Module locks have a real time clock that will be set through the User Interface; it is recommended to verify correct date and time particularly those locks operating under Daylight Saving Time (DST).

\*\* Network module units only

## Installing the Network Module

**IMPORTANT:** The batteries must be removed prior to removing and/or inserting the network module:

- Remove battery cover
- Remove batteries
- Remove and/or insert network module
- Reinstall batteries

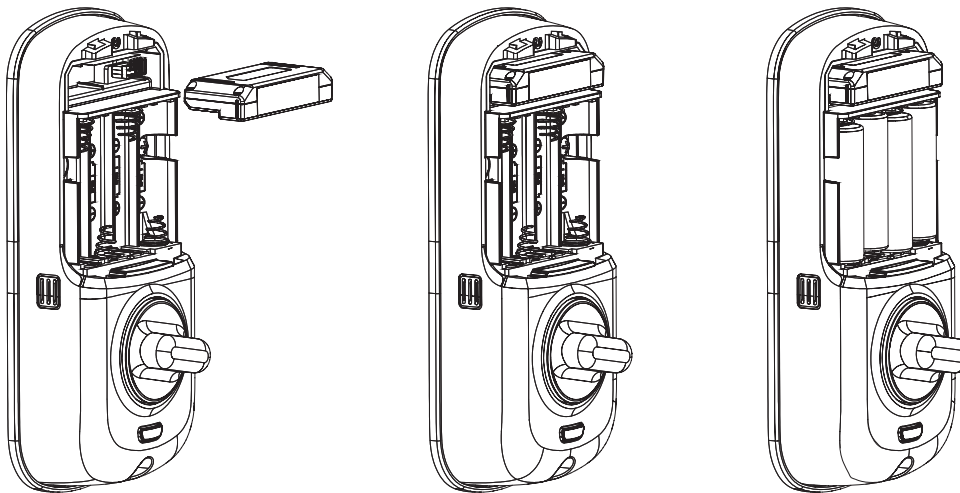

**Use feature programming step 7 (page 14) for enrollment of the Network Module.**

## PIN CODE MANAGEMENT SAMPLE SHEETS

PIN Code Management (No Network Module - Up to 25 Users)

Location:		Door Number:		User	User Name	User #	PIN Code
User Type	User Name	User #	PIN Code				
Master				User 13			
User 01				User 14			
User 02				User 15			
User 03				User 16			
User 04				User 17			
User 05				User 18			
User 06				User 19			
User 07				User 20			
User 08				User 21			
User 09				User 22			
User 10				User 23			
User 11				User 24			
User 12				User 25			



## ONLINE LITERATURE AND TEMPLATES

For the latest information on Yale products visit our website at [www.yalelocks.com](http://www.yalelocks.com). Click on the “Literature” button to find the most up-to-date catalogs, parts manuals, templates, specifications and installation instructions.



Scan this code to view installation videos

---

[www.yalehome.com](http://www.yalehome.com)

Yale ® is a registered trademark of Yale Security Inc., an ASSA ABLOY Group company. All rights reserved. Yale Real Living™ is a trademark of Copyright © 2011, Yale Security Inc., an ASSA ABLOY Group company. All rights reserved. Reproduction in whole or in part without express written permission of Yale Security Inc., an ASSA ABLOY Group company is prohibited.

**YALE**, with its unique global reach and range of products, is the world’s favorite lock — the preferred solution for securing your home, family and personal belongings.

**ASSA ABLOY** is the global leader in door opening solutions, dedicated to satisfying end-user needs for security, safety and convenience.