



Duplex Receptacle (Top Controlled) Scene Capable Receptacle

Cat. No. VRR15-1L - 15A - 125VAC, 60Hz
Incandescent-1800W – Magnetic Low-Voltage-1800VA (1440W)
Electronic Low-Voltage-1800W – Fluorescent-1800VA – Supplemental-1/2 HP

INSTALLATION INSTRUCTIONS

WARNINGS AND CAUTIONS:

- To be installed and/or used in accordance with electrical codes and regulations.
- If you are unsure about any part of these instructions, consult an electrician.
- To ensure that there is adequate room for wires, we recommend using at a minimum 3-1/2 inch deep wallboxes. For single-gang applications, this would be at a minimum an 18-cubic inch wallbox.

WARNINGS AND CAUTIONS:

- Disconnect power at circuit breaker or fuse when servicing, installing or removing fixture.
- Maximum wire length cannot exceed 300 ft (90 m).
- Use this device **with copper or copper clad wire only**.

INTRODUCTION

Leviton's Vizia RF +™ Z-Wave® components are designed to communicate with each other via Radio Frequency (RF) to provide remote control of your lighting. Using RF technology allows Leviton to provide the greatest signal integrity possible. Each module in Leviton's Vizia RF +™ component line is a Z-Wave® enabled device. In a Z-Wave® network, each device is designed to act as a router. These routers will re-transmit the RF signal from one device to another until the intended device is reached. This ensures that the signal is received by its intended device by routing the signal around obstacles and radio dead spots. The Scene Capable Electronic Receptacle is compatible with most Z-Wave® enabled networks, from different manufacturers and can also be used with other devices displaying the Z-Wave® logo.

CAUTION:

Remember to exercise good common sense when using the Timer features of your Remote – especially when scheduling unattended devices. There can be some unexpected consequences if not used with care. For example, an empty coffee pot can be remotely turned on. If that should happen, your coffee pot could be damaged from overheating. If an electric heater is turned on by remote control while clothing is draped over it, a fire could result. **DO NOT USE** the remote for the control of high power heating appliances such as portable heaters.

FEATURES

- Receptacle ON/OFF
- Scene Capable
- ON/OFF LED
- Two way communication
- RF reliability
- Ease of installation – No new wiring
- Compatible with other Z-Wave® enabled devices

Tools needed to install your Receptacle

- | | | |
|------------------------------|-----------------|--------|
| Slotted/Phillips Screwdriver | Electrical Tape | Pliers |
| Pencil | Cutters | Ruler |

Changing the color of your Receptacle:

Your Receptacle includes three color options. The Receptacle ships with the White frame attached. To change color of frame, proceed as follows:

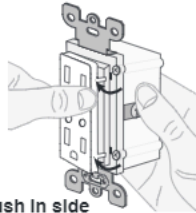

Push In side at tab to release

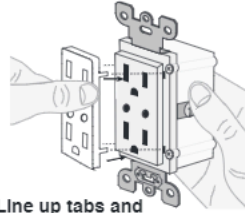

Line up tabs and press in sides one at a time to attach

INSTALLING YOUR RECEPTACLE

NOTE: Use check boxes when Steps are completed.

Step 1 **WARNING: TO AVOID FIRE SHOCK OR DEATH; TURN OFF POWER** at circuit breaker or fuse and test that power is off before wiring!

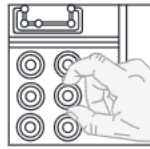
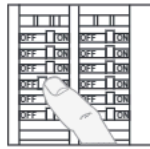

Step 2 **Identifying your wiring application (most common):**
NOTE: If the wiring in your wall box does not resemble any of these configurations, consult a qualified electrician.

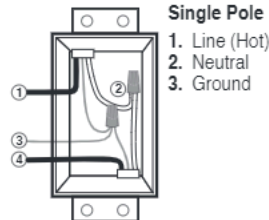

Step 3 Preparing and connecting wires:

This receptacle can be wired using side wire terminal screws or through backwire openings. Choose appropriate wire stripping specifications accordingly.

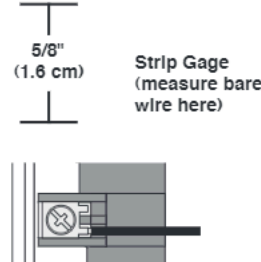
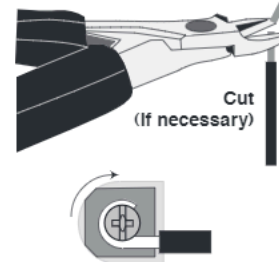

Side Wire Connection

Side wire terminals accept #14-12 AWG **solid copper wire only**.

- Make sure that the ends of the wires from the wall box are **straight (cut if necessary)**.
- Remove insulation from each wire in the wall box as shown.

Back Wire (either hole may be used)

Back wire openings accept #14-12 AWG **solid copper wire only**.

Step 4 Single Pole Wiring Application:

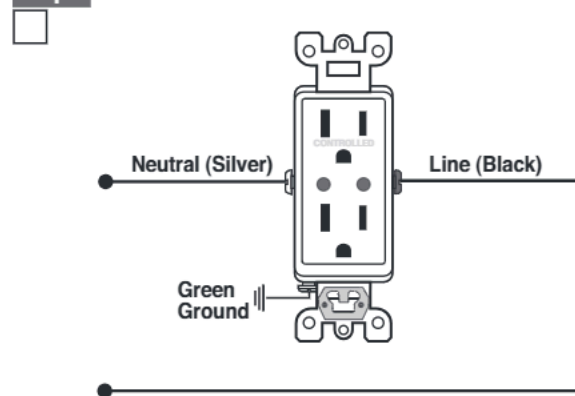

WIRING RECEPTACLE:

Connect wires per **WIRING DIAGRAM** as follows:

- Green or bare copper wire in wall box to Green terminal screw.
- Line Hot wall box wire to terminal screw marked "LINE".
- Line Neutral wall box wire to terminal screw marked "NEUTRAL".
- **Proceed to Step 5.**

Step 5 Testing your Receptacle prior to mounting in wall box:

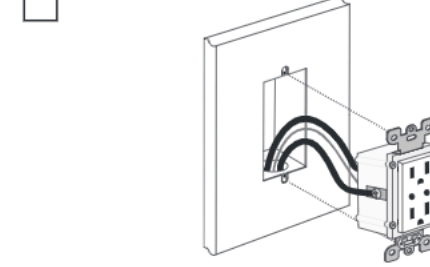

- Position all wires to provide room in outlet wall box for device.
 - Partially screw in mounting screws in wall box mounting holes.
- NOTE:** Dress wires with a bend as shown in diagram in order to relieve stress when mounting device.

- Restore power at circuit breaker or fuse.
- Locator light should turn ON.

If locator light does not turn ON, refer to the **TROUBLESHOOTING** section.

Step 6 Receptacle Mounting: TURN OFF POWER AT CIRCUIT BREAKER OR FUSE.

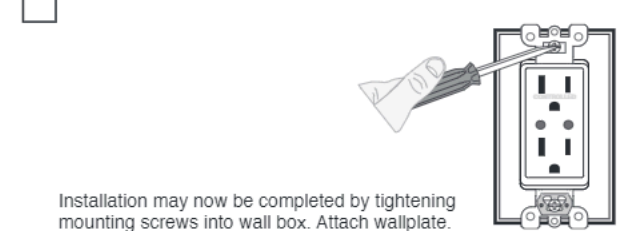

Step 7 Restore Power:

Restore power at circuit breaker or fuse. **Installation is complete.**

Step 8 Including Receptacle into Z-Wave® Network:



NOTES:

- Receptacle will be included as a switch
 - If using a non-Leviton Programmer/Controller, refer to the Programmer/Controller instruction sheet for Including a device.
 - If using VRCPG install checklist go directly to step B.
- A)** If using a Leviton Z-Wave® Programmer/Controller, Cat. No. VRCPG, press the Menu button and scroll down to System. Press the center button to select System Menu. Choose Advanced. Press the center button to select Advance Install.
- B)** While standing close to the receptacle (approximately 1 foot), press the center button to <Include> device in the network.
NOTE: Only one device may be included at a time. **DO NOT** put multiple devices into the Inclusion mode at any time.
- C)** While the Programmer/Controller is in the Inclusion mode and the Locator LED is ON on the receptacle, press the button on the receptacle. The Programmer/Controller will verify inclusion. If the receptacle is flashing Amber while in the Inclusion mode, the Programmer/Controller is still trying to communicate with the receptacle. Wait until the device stops flashing, then press the receptacle program button.
NOTE: If the Locator LED on the receptacle turns solid Red while including, there has been a communication error. Refer to Troubleshooting section.
- D)** The Primary Programmer/Controller will assign a node ID number (Name) for this device.
NOTE: This ID number (Name) will be stored in the controller to be used for future reference.
NOTE: You may name or edit your device at this time.
- E) The receptacle is now installed in the network.**

NOTE: If the receptacle has been successfully Included in the network and the user tries to Include it again without first excluding it from the network, the receptacle will retain the first node ID it had received and ignore the second.

Programmer/Controller
Cat. No. VRCPG

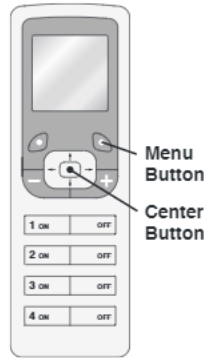

Menu Button
Center Button

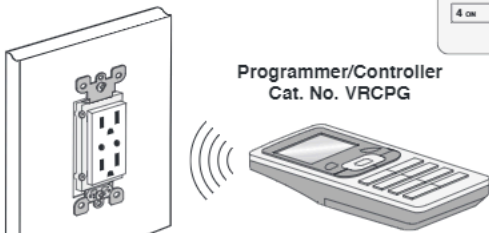

Programmer/Controller
Cat. No. VRCPG

NOTE: Programmer/Controller must be in close proximity to receptacle when including in the network.

Step 9 Excluding Receptacle from Z-Wave® Network:



NOTE: It is very important to accurately Exclude devices from the network when moving or removing a device from a Z-Wave® network. This ensures that all information has been removed from your Primary.

- A)** If using a Leviton Z-Wave® Programmer/Controller, Cat. No. VRCPG, press the Menu button and scroll down to System. Press the center button to select. Choose Advanced. Press the center button to select Advanced Install. Scroll down to exclude.
- B)** While standing close to the receptacle (approximately 1 foot), press the center button to <Exclude> device from the network.
- C)** While the Programmer/Controller is in the Exclusion mode and the locator LED is ON press the button. The Programmer/Controller will verify Exclusion and the locator LED will turn OFF. If the receptacle is flashing Amber while in the Exclusion mode, the Programmer/Controller is still trying to communicate with the receptacle. Wait until the device stops flashing, then press the receptacle program button.

Factory Default:

If your receptacle is not responding, or you are unable to control it after you have tried to Include/Exclude it multiple times, it may be necessary to reset the receptacle to its original factory settings. To accomplish this, proceed as follows:

- On the receptacle, press and hold the program button until the locator LED turns Amber and then flashes Red. The receptacle is now reset. Once the receptacle is reset, it will be necessary to Re-Include it to a network before it can be used.

CAUTION: SETTING A DEVICE TO A FACTORY DEFAULT DOES NOT EXCLUDE THAT DEVICE FROM A NETWORK. THE EXCLUSION PROCEDURE MUST STILL BE FOLLOWED TO REMOVE THE DEVICE FROM THE PRIMARY CONTROLLER'S INFORMATION TABLE. FAILURE TO DO SO MAY RESULT IN SYSTEM THAT IS SLOW TO RESPOND, OR MAY FAIL TO RESPOND TO SOME DEVICES.

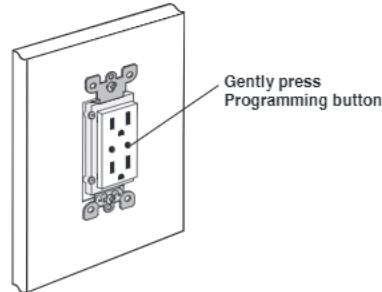

Gently press
Programming button

OPERATION

NOTE: The locator light will illuminate when receptacle is connected.

If there is a power outage, when the power is restored, the lights will return to the last setting before the power interruption.

Cleaning: Clean with a damp cloth. **DO NOT** use chemical cleaners.

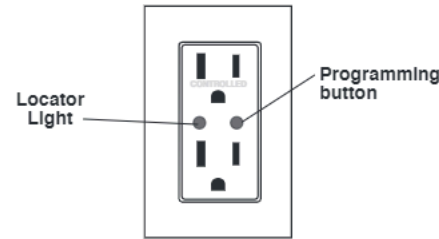

Locator Light

Programming button

TROUBLESHOOTING

- **Receptacle has no power**
 - Receptacle has a bad connection.
 - Wires not secured firmly under terminal screws of receptacle.
- **Locator LED does not turn ON**
 - Circuit breaker or fuse has tripped.
 - Neutral connection is not wired.
 - Press programming button.

For additional information, contact Leviton's
Techline at 1-800-824-3005 or visit Leviton's
website at www.ViziaRFplus.com

Protected under U.S. Patent Number 6,388,399 and patents pending
and licensed under U.S. Patents Numbers 5,905,442, and 5,982,103

FCC COMPLIANCE STATEMENT

This device complies with Part 15 of the FCC Rules. Operation is subject to following two conditions: (1) this device may not cause harmful interference, and (2) this device must accept any interference received, including interference that may cause undesired operation of the device.

This equipment has been tested and found to comply with the limits for a Class B Digital Device, pursuant to Part 15 of the FCC Rules. These limits are designed to provide reasonable protection against harmful interference in a residential installation. This equipment generates, uses, and can radiate radio frequency energy and, if not installed and used in accordance with the instructions, may cause harmful interference to radio communications. However, there is no guarantee that interference will not occur in a particular installation. If this equipment does cause harmful interference to radio or television reception, which can be determined by turning the equipment OFF and ON, the user is encouraged to try to correct the interference by one or more of the following measures:

- Reorient or relocate the receiving Antenna.
- Increase the separation between the equipment and the receiver.
- Connect the equipment into an outlet on a circuit different from that to which the receiver is connected.
- Consult the dealer or an experienced radio/tv technician for help.

FCC CAUTION

Any changes or modifications not expressly approved by Leviton Manufacturing Co., Inc., could void the user's authority to operate the equipment.

LIMITED 5 YEAR WARRANTY AND EXCLUSIONS

Leviton warrants to the original consumer purchaser and not for the benefit of anyone else that this product at the time of its sale by Leviton is free of defects in materials and workmanship under normal and proper use for five years from the purchase date. Leviton's only obligation is to correct such defects by repair or replacement, at its option, if within such five year period the product is returned prepaid, with proof of purchase date, and a description of the problem to **Leviton Manufacturing Co., Inc., Att: Quality Assurance Department, 201 North Service Road, Melville, New York 11747**. This warranty excludes and there is disclaimed liability for labor for removal of this product or reinstallation. This warranty is void if this product is installed improperly or in an improper environment, overloaded, misused, opened, abused, or altered in any manner, or is not used under normal operating conditions or not in accordance with any labels or instructions. **There are no other or implied warranties of any kind, including merchantability and fitness for a particular purpose**, but if any implied warranty is required by the applicable jurisdiction, the duration of any such implied warranty, including merchantability and fitness for a particular purpose, is limited to five years. **Leviton is not liable for incidental, indirect, special, or consequential damages, including without limitation, damage to, or loss of use of, any equipment, lost sales or profits or delay or failure to perform this warranty obligation.** The remedies provided herein are the exclusive remedies under this warranty, whether based on contract, tort or otherwise.