

GD00Z-4 GoControl™

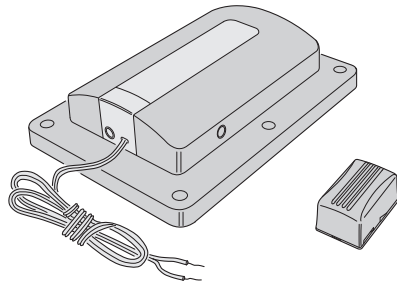

GARAGE DOOR OPENER REMOTE COMMAND TRANSCEIVER with TILT SENSOR



Installation Instructions

NORTEK
 SECURITY & CONTROL
 USA & Canada (800) 421-1587 & (800) 392-0123
 (760) 438-7000 - Toll Free FAX (800) 468-1340
 www.nortekcontrol.com

1 PRODUCT DESCRIPTION

GD00Z-4 Overview

- A garage door opener remote command transceiver with built-in Z-Wave technology.
- Allows remote operation of a garage door opener using Z-Wave controllers.
- Acts as a Z-Wave repeater to improve communications within the Z-Wave mesh network.

GD00Z-4 Summary of Operation

- GD00Z-4 connects to the garage door opener's pushbutton wall console terminals.
- A wireless tilt sensor mounts on the garage door and reports the door's position to the GD00Z-4.
- GD00Z-4 responds to Z-Wave commands from Z-Wave controllers to open or close the garage door.
- A warning indicator light flashes and a beeper sounds for 5 seconds before the door begins to move.
- If the door does not completely open or close, a second open or close command can be sent after 30 seconds.
- If the door does not completely open or close after the second attempt, the GD00Z-4 operation is suspended until a local garage door pushbutton is activated.

Z-Wave Information

- Z-Wave® is a registered trademark of Sigma Designs Inc. and/or its subsidiaries.
- Z-Wave is an Interoperable two-way RF mesh networking technology designed for use with a Z-Wave gateway/controller and other Z-Wave enabled devices.
- Replication is the process of copying or transferring your Z-Wave network from one controller to another.
- This is a Security enabled Z-Wave product and must be used with a Security enabled Z-Wave controller in order to fully utilize this product. As such, this device will not respond to Basic CC commands.
- ASSOCIATION: The GD00Z-4 supports 1 Group with 1 Node. Group 1 must be assigned the Node ID of the controller to which unsolicited notifications from the GD00Z-4 will be sent. The Z-Wave controller should set this association automatically after inclusion.

2 SAFETY NOTES

⚠ WARNING ⚠
 This operator system is equipped with an unattended operation feature. This door could move unexpectedly. NO ONE SHOULD CROSS THE PATH OF A MOVING DOOR!

⚠ WARNING ⚠
 This system can be installed on sectional type (roll up) doors only per (UL-325). DO NOT INSTALL ON ONE-PIECE DOORS!

⚠ WARNING ⚠
 The Remote Command Transceiver must be mounted in the garage, in sight of the garage door, where the visual and audible movement warning indicators can be clearly seen and heard.

⚠ WARNING ⚠
 Do not install the Remote Command Transceiver on garage door operators manufactured prior to 1993 (models without an operational safety beam entrapment detection system).

3 PRODUCT COMPONENTS

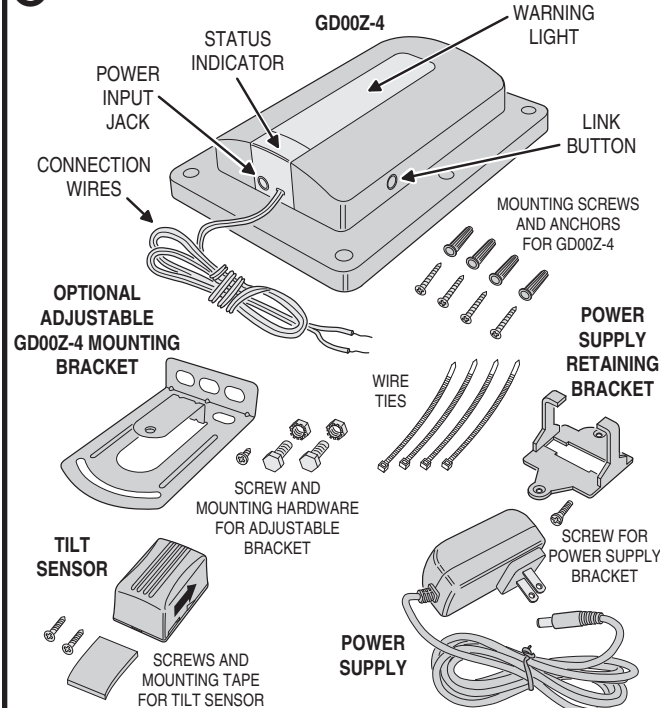

4 TILT SENSOR INSTALLATION AND BATTERY

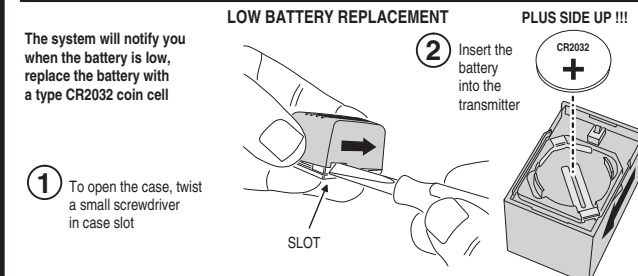
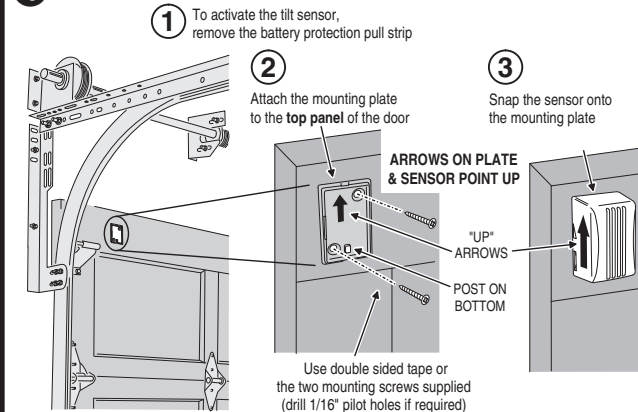

5 PAIRING (INCLUDING) WITH THE SYSTEM

Note: Plug in the GD00Z-4 near your Z-Wave Controller for these steps

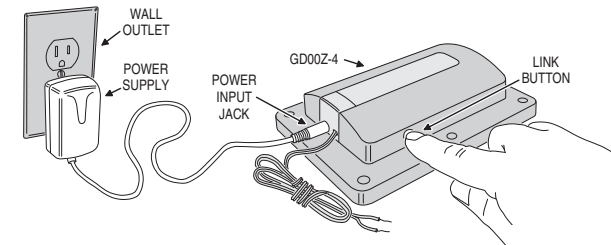

TO INCLUDE THE GD00Z-4 INTO YOUR CONTROLLER

- 1 Place your Z-Wave Controller into Discovery or Include mode.
- 2 Press and release the link button on the GD00Z-4.
- 3 Confirm that the GD00Z-4 was recognized by your Z-Wave Controller.

Refer to your Z-Wave Controllers instructions for additional information on including devices.

TO EXCLUDE THE GD00Z-4 FROM YOUR CONTROLLER

- 1 Place your Z-Wave Controller into Exclude mode.
- 2 Press and release the link button on the GD00Z-4.
- 3 Confirm that the GD00Z-4 was excluded by your Z-Wave Controller.

Refer to your Z-Wave Controllers instructions for additional information on excluding devices.

6 GD00Z-4 MOUNTING

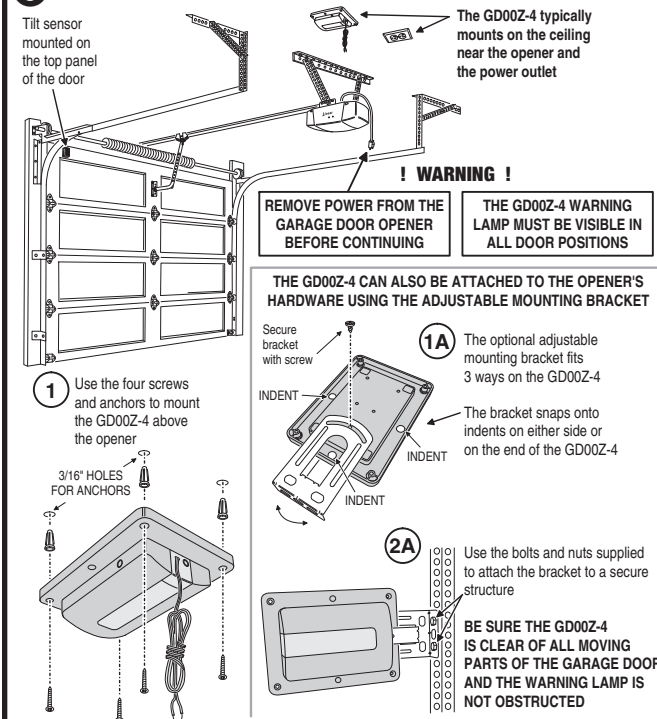

7 GD00Z-4 CONNECTIONS

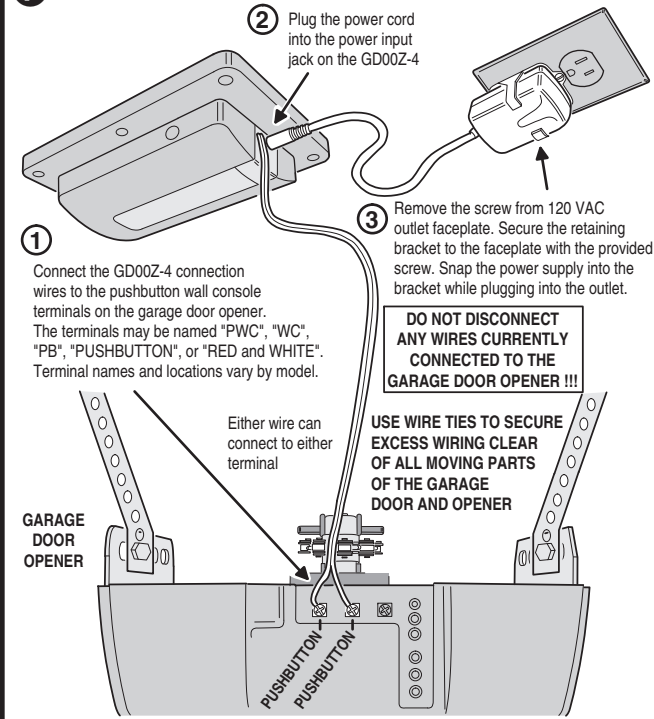

8 SYSTEM OPERATION

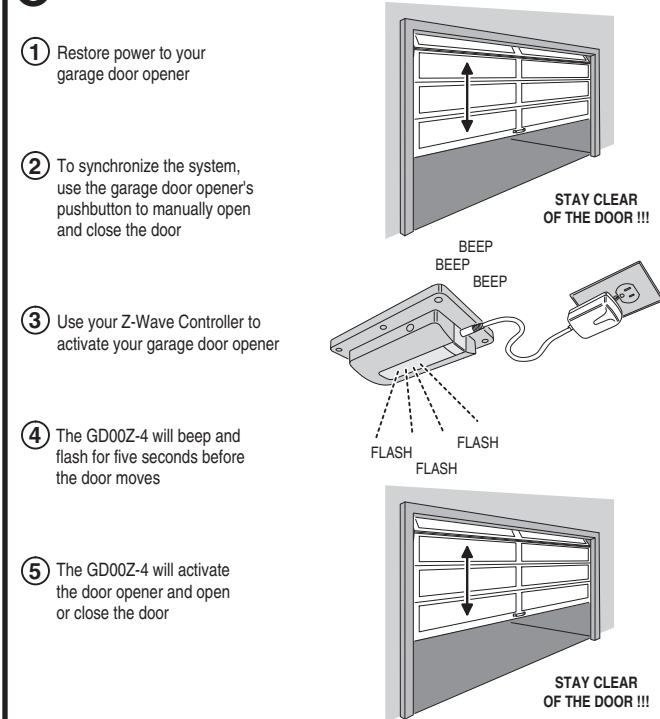

9 OPERATION NOTES

- The warning light will flash and the warning beeper will sound for five seconds before the door opener is activated. **STAY CLEAR OF THE DOOR, AND DOOR OPENER. THEY ARE ABOUT TO MOVE!**
- If the door does not completely open or close after remote activation, the GD00Z-4 will allow user to try to operate the door one more time. If the second attempt fails, the GD00Z-4 will go into lock-out mode. See Note #3.
- If the GD00Z-4 is in lock-out mode and will not accept remote commands, activate the door from the pushbutton wall console.
- Once the GD00Z-4 has initiated the movement of the garage door, another command cannot be sent for 30 seconds. This eliminates the chance of "bouncing" the garage door and possibly damaging the garage door opener.

10 TROUBLESHOOTING

| PROBLEM | POSSIBLE CAUSE | CORRECTIVE ACTION |
|---|---|--|
| Unable to include in Z-Wave network. | GD00Z-4 was not properly excluded from a previous Z-Wave network. | Reset the GD00Z-4 by pressing the LINK button 5 times. A quick beep then a longer beep indicates the reset. Use this procedure only in the event that the network primary controller is missing or otherwise inoperable. |
| The GD00Z-4 does not flash or beep when activated. | No power to the GD00Z-4. | 1. Make sure the power supply is plugged in securely to a live outlet. 2. Make sure the power cord is plugged in securely to the GD00Z-4. |
| The GD00Z-4 flashes and beeps when activated but the door does not move. | Obstruction blocking the door or incorrect wiring. | 1. Make sure that there are no obstacles preventing the door from moving. 2. Make sure that the GD00Z-4 connection wires are connected to the proper terminals on the garage door opener. Trace the wires from the garage door opener's pushbutton wall console to the door opener. This is where the GD00Z-4 connection wires should be connected. |
| Garage door opens or closes, but the status does not change on the Z-Wave Controller. | The tilt sensor signal is not being received by the GD00Z-4. | 1. Make sure the tilt sensor is mounted correctly on the garage door, with the arrow pointing up. 2. Make sure the battery pull tab has been removed from the tilt sensor. 3. Replace the battery in the tilt sensor. |

NORTEK SECURITY & CONTROL LIMITED WARRANTY

This Nortek Security & Control product is warranted against defects in material and workmanship for twelve (12) months. **This warranty extends only to wholesale customers** who buy direct from Nortek Security & Control or through Nortek Security & Control's normal distribution channels. Nortek Security & Control does not warrant this product to consumers. Consumers should inquire from their selling dealer as to the nature of the dealer's warranty, if any. **There are no obligations or liabilities on the part of Nortek Security & Control LLC for consequential damages arising out of or in connection with use or performance of this product or other indirect damages with respect to loss of property, revenue, or profit, or cost of removal, installation, or reinstallation.** All implied warranties, including implied warranties for merchantability and implied warranties for fitness, are valid only until the warranty expires. **This Nortek Security & Control LLC Warranty is in lieu of all other warranties express or implied.**

All products returned for warranty service require a Return Product Authorization Number (RPA#). Contact Nortek Security & Control Returns at 1-855-546-3351 for an RPA# and other important details.

REGULATORY NOTICES

Changes or modifications not expressly approved by the manufacturer could void the user's authority to operate the equipment.

Les changements ou modifications non approuvés expressément par la partie responsable de la conformité pourrait annuler l'autorité de l'utilisateur à faire fonctionner l'équipement.

This equipment has been tested and found to comply with the limits for Class B Digital Device, pursuant to Part 15 of the FCC Rules. These limits are designed to provide reasonable protection against harmful interference in a residential installation. This equipment generates and can radiate radio frequency energy and, if not installed and used in accordance with the instructions, may cause harmful interference to radio communications. However, there is no guarantee that interference will not occur in a particular installation. If this equipment does cause harmful interference to radio or television reception, which can be determined by turning the equipment off and on, the user is encouraged to try to correct the interference by one or more of the following measures.

- Reorient or relocate the receiving antenna
- Increase the separation between the equipment and receiver
- Connect the equipment into an outlet on a circuit different from that to which the receiver is connected
- Consult the dealer or an experienced radio/TV technician for help

This Class B digital apparatus complies with Canadian ICES-003.

Cet appareil numérique de la classe B est conforme à la norme NMB-003 du Canada.

GD00Z-4 Specifications

Power Supply: Input: 120 VAC, 0.8 A
 Output: 12 VDC, 2 A

Operating Temperature: -4°—122° F (-20°—50° C)

Audible Alarm: 45 db @ 10 feet

Stroke: 360 Lumens

Communications: Z-Wave (908.4 MHz)

Mounting: Screws and anchors to the ceiling, or bracket to the opener's hanging hardware

Tilt Sensor Specifications

Power Supply: Type CR2032 Coin Cell Battery

Operating Temperature: -4°—122° F (-20°—50° C)

Battery Life: 24 Months (typical)

Communications: Proprietary 345 MHz

Range: 100 feet line-of-sight to GD00Z-4

Mounting to Garage Door: Double-sided tape or two mounting screws

(Specifications subject to change without notice)

NOTICE TO USERS IN CALIFORNIA - CR COIN CELL LITHIUM BATTERY INFORMATION: THIS PRODUCT CONTAINS A CR COIN CELL LITHIUM BATTERY WHICH CONTAINS PERCHLORATE MATERIAL - SPECIAL HANDLING MAY APPLY - SEE www.dtsc.ca.gov/hazardouswaste/perchlorate

KEEP AWAY FROM SMALL CHILDREN. IF BATTERY IS SWALLOWED, PROMPTLY SEE A DOCTOR. DO NOT TRY TO RECHARGE THIS BATTERY. DISPOSAL OF USED BATTERIES MUST BE MADE IN ACCORDANCE WITH THE WASTE RECOVERY AND RECYCLING REGULATIONS IN YOUR AREA.